

# Forest regeneration

- Natural regeneration



- Artificial regeneration



# Artificial regeneration

## Advantages

- + genetic quality
- + guaranteed of species composition
- + choice of planting stock
- + faster growth
- + not necessary to do it in a seed year

## Disadvantages

- expensive forest establishment
- low quality of planting
- low number of plants
- bad influence on soil



# Artificial regeneration of forest stands



# REFORESTATION (artificial forest regeneration)

- **Differentiation**
  - according to the site
  - according to the function of the stand
  - according to the danger to the stand
- **Realization**
  - sowing or planting
  - it starts by cutting the first tree or first intervention in the soil, and it ends by state of young plantation that don't need further protection (against weed, insect, game, fungi...)

!It is a compromise between technology, economics and biology. Biology is crucial!

!It affects the quality of the forest stands for decades!

!There is never only one way to a successful recovery (with some exceptions)!



**Before any regeneration, you need to find a fundamental solution (based on the silvicultural plan) – the regeneration analysis.**

Function of the forest stand => complex analysis of the ecotope (chemical and physical characteristics of the soil, skeleton, soil compacting, water, frost, wind, weed, game, inclination, exposure, how the surrounding stands grow or how they are damaged – you need to identify the key negative factors) → preparation of the site (soil) → tree species → type and maturity of the planting stock → technique of planting → plants density → mixing of tree species → care of the plantation (weed, game, rodents, abiotic agents)

**MUTUAL RELATIONSHIPS AND CORRELATIONS**

# ***FOREST REGENERATION BY SOWING***



# **REGENERATION TECHNIQUES - SOWING**

## **Sowing – *positives***

- No need of any “production” of planting stock (in forest nurseries)
- No need of costly, long-time seed storage
- The plant is developing at the same site → no shock when transported to the regeneration site (planting site)
- Can be genetically identical to the parent stand (this may be a negative characteristic as well)
- Simple technology
- Cheap



## **Sowing – negatives**

- **The seeds are not protected against the effects of biotic and abiotic agents**
- **Irregular development of the germinated seeds seedlings**
- **Requires great care**
- **High mortality**
- **The seeds are expensive**
- **Damage by rodents, wild boars (forest pigs), birds**
- **Less developed root system**

## Sowing is recommended for:

- **Quercus, Acer, Fraxinus, Juglans, Sorbus, Alnus, Betula, Robinia pseudoacacia, Aesculus hyppocastanum and shrubs**
- **Exceptionally: *Picea abies*, *Pinus sylvestris*, *Abies alba* – seeds of lower quality (does not make any sense without soil preparation)**
- **Only for oak sowing: mechanized, after whole-area ploughing; for walnut tree: using a furrow planting machine; other species: manually; other techniques are used in some countries though**

# Mechanized grooving for sowing





# Mechanized preparation of soil and sowing





# Mechanized preparation of soil and sowing





**Furrow planting machine –  
usage also for walnut sowing**





## ***SOWING TECHNIQUE***

### **– SAME AS IN FOREST NURSERIES**

- ***Depth of sowing*** – 2x the longest axis of the seed  
(autumn sowing 4x)
- ***„Backfill“ (covering)***
  - large size seeds: cover them with the soil
  - small size seeds: cover them with sand or perlite
- ***Sowing time***
  - preferably: in the spring; autumn - dormant seeds
  - autumn sowing: more damage by biotic agents and frost
  - do not sow germinated seeds

- **Sowing dose** - standardized – can be calculated

$$N = \frac{10 \cdot A \cdot V}{GC \cdot \check{C}} \cdot k$$

N - dose in grams per area unit

A – weight of 1000 seeds

V - required number of plants per area unit in pieces

GC - germination capacity in %

Č - seed purity in %

k - coefficient (oak = 2, birch = 10)

***Quercus*** – 200 kg/ha,

***Juglans nigra*** – 500 kg/ha,

***Betula*** – 40 kg/ha

- ***Sowing scheme (mainly spot-like type)***
  - **dig the soil (spot) to the depth of 15 cm, remove stones, roots, weed**
  - **level the soil surface, compact it**
  - **push the seeds into the soil**
  - **refill (do not compact the cover layer = „backfill“)**
  - **cover with a mulch foil, brushwood**

**REGULAR SPACING!**

**ELIMINATE THE WEED!**



## TYPES OF SOWING

- ***Direct sowing*** (*Sorbus*, *Betula*, *Alnus*) – also on snow, also cut branches; always: soil scarification
  - especially on calamity clearing areas
- ***Partial sowing***
  - point – pinch – “under the hoe”
  - spot-like (bowl-like - min. 60x60 cm), sometimes in belts (width min. 40 cm)
  - in rows
- ***Special techniques***
  - sowing into vegetation containers and briquettes
  - sowing under artificial covers
  - throwing out pressed *Sorbus*
  - nest technique – only at extreme sites
  - sowing into root flare
  - sowing thrown from plane



# Sowing into root flare

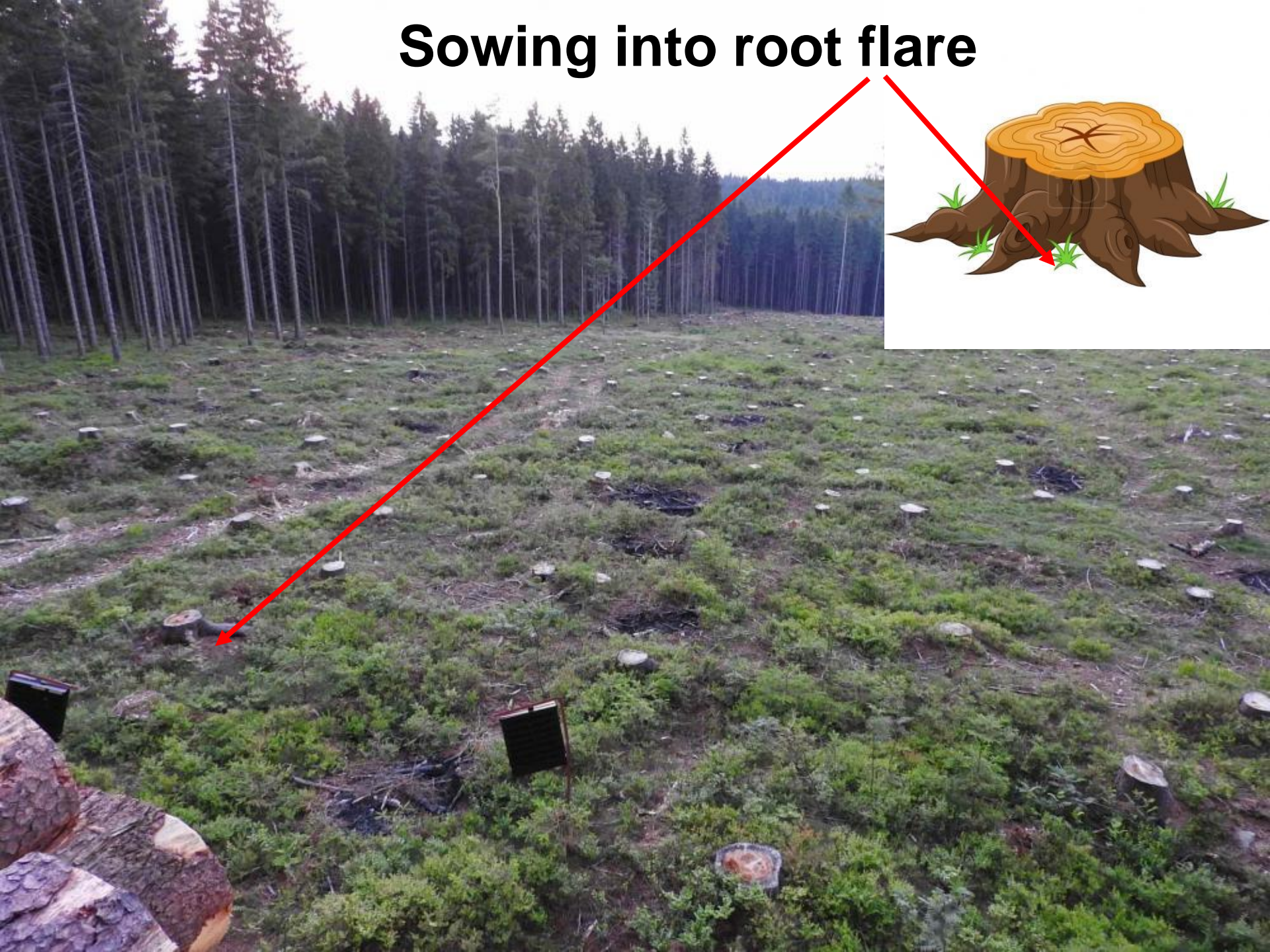

***SOWING INTO VEGETATION  
CONTAINERS***



# SOWING INTO VEGETATION CONTAINERS

- **It solves** - physical and chemical properties of the “soil”
  - hydrothermal regime of the soil and air
- **Procedure**
  - container – plastic, impregnated paper, wood (approx. 5x20 cm)
  - put quality substrate in the container – and compact it
  - use the top quality seeds (not germinated)
  - *backfill* - small size seeds: perlite, sand
    - large size seeds: soil

## CAREFUL SOWING – THE SAME AS IN NURSERIES

- dig a hole
- put organic substrate onto the bottom
- place the container into the hole and cover it with substrate (the sowing at the level of the soil surface; not under the level)
- potential damage: by rodents, moluscs, game, snow







Sowing into vegetation containers





**Sowing into vegetation containers**



# Sowing into vegetation containers



# ***SOWING UNDER PLASTIC COVERS***



***Forest regeneration by sowing*** – the cheapest forest regeneration

**If the hydro-thermal regime is not proper - mortality**

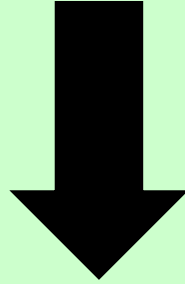

**use of plastic covers  
(very small greenhouses)**

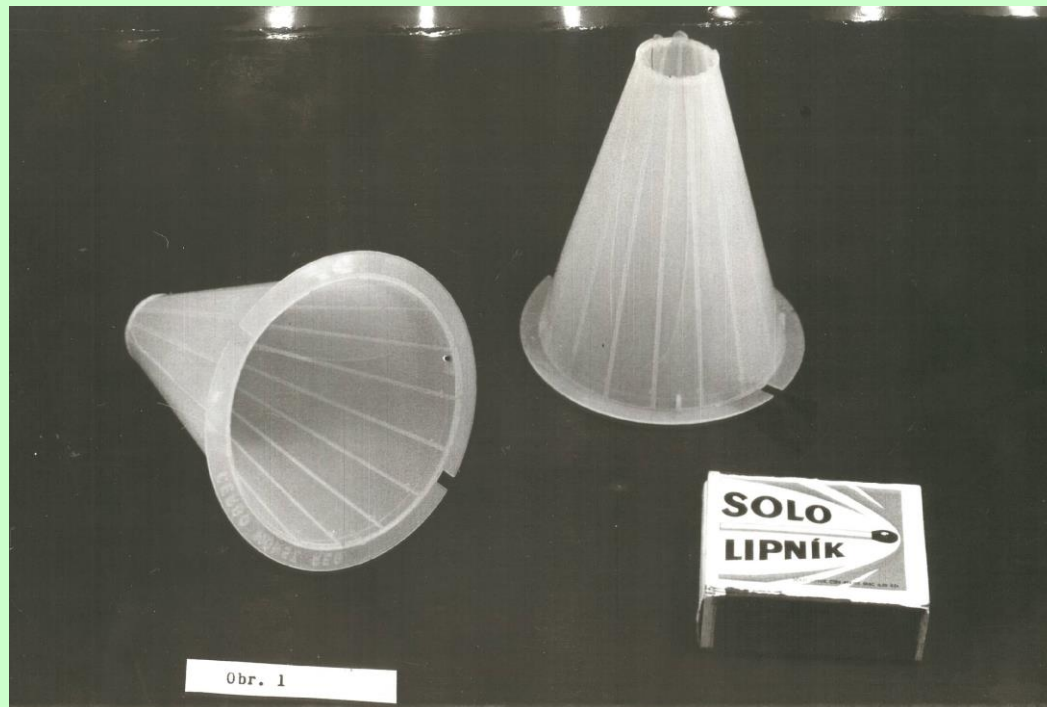

# Sowing 4 pieces of spruce seeds under plastic covers - characteristics of the growth of the seedlings, condition of the covers (2 years after the sowing)

<b>PARAMETER</b>	<b>Forest altitudinal zone</b>	
	<b>4.</b>	<b>7.</b>
<b>% covers with 1 seedling</b>	<b>17</b>	<b>11</b>
<b>% of covers with 2 seedlings</b>	<b>22</b>	<b>46</b>
<b>% of covers with 3 seedlings</b>	<b>17</b>	<b>18</b>
<b>% covers with 4 seedlings</b>	<b>0</b>	<b>2</b>
<b>% covers without seedlings</b>	<b>44</b>	<b>23</b>
<b>height above ground (cm)</b>	<b>6.9</b>	<b>5.6</b>
<b>% undamaged covers</b>	<b>47</b>	<b>14</b>

---

**550 m above sea    910 m above sea**



## **SOWING UNDER PLASTIC COVERS** – *conclusions*

- **Do not use:**
  - **on dry and windward habitats**
  - **where the soil or snow is moving**
- **Eliminate any negative influence of weeds, game and rodents**
- **Use only non-germinated seeds; do not backfill the seeds**
- **Remove the covers after two years**
- **Check anchoring of the covers**

***Artificial forest  
regeneration by planting***

# **PLANTING**

## **a) Positives**

- better utilization of the seeds
- the planting stock is higher than the vegetation
- the root system is more developed

## **b) Negatives**

- forest nurseries, storage areas
- the plants can be damaged during transport and handling
- shock when replanted – nearly zero increments
- deformation of the root system
- price

# PLANTING TYPES

elevated  
level

below-level  
(in depth)

according to the position of the root system  
against the level of the original soil surface

normal

“sunk”

“semi-sunk”

according to the position of the root collar  
against soil

↑  
recommendable for

- *dry habitats,*
- *summer and autumn planting,*
- *reproduced auto-vegetatively (by means of springs) always get sunk,*
- *weak and deformed root system*



# GROWTH PERIODS OF THE ROOT SYSTEM

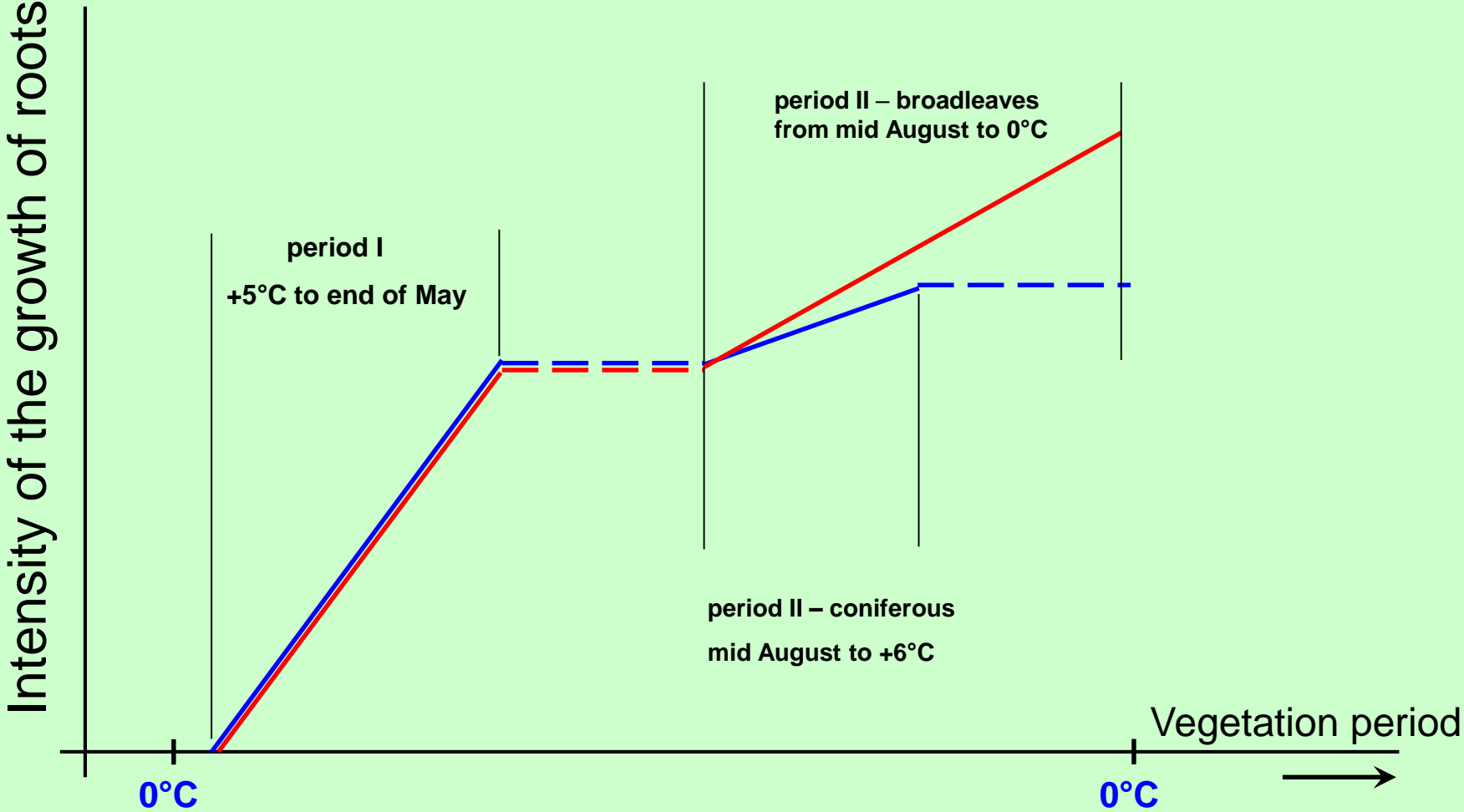

**TIME OF PLANTING – at the beginning of the period of the growth of roots**



# SPRING PLANTING – bare-rooted planting stock

- all woody species
- was the most suitable period
- the plants need to be in dormancy (important in large-sized plants and *Larix decidua*)
- partially in bud: *Pseudotsuga menziesii*, *Abies grandis*
- Time sequence!!!: large-sized plants, *Larix decidua*, *Quercus*, other deciduous, *Alnus*, *Betula*, coniferous, *Picea abies*, *Pseudotsuga menziesii*, *Abies grandis*
- planting time – when the soil get defrosted and the snow melts away (+5°C)
- the planting needs to be stopped if the plants are in bud, or if the temperature exceeds 20°C

# Planting of bare-rooted planting stock from mid August to mid September – SUMMER PLANTING

- “suitable” for coniferous (mainly *Picea abies*, *Pseudotsuga menziesii*)
- unsuitable for broadleaves and *Larix decidua*
- conditions
  - the growth of the above-ground part is completed
  - the terminal increment is partially lignified, the plants are well fertilized, no dried parts
  - planting “from earth to earth”
  - only at wet and covered habitats
  - need to be planted into wet soil
  - there must be contact between the roots and the soil
  - not very tall plants, with a well- developed root system
  - normal autumn in terms of precipitation and temperature
  - weeds need to be eliminated (cut)

*Protection against frost:*

- plants partially sunk
- plants mulched in

**Necessary: protection against game**  
**– these plants are often damaged!!!**

## AUTUMN PLANTING – bare-rooted planting stock from October to the beginning of the frost season

- suitable for *Larix decidua* and broadleaves, use of planting bar, hole planting is acceptable
- conditions • the growth of the above-ground part is completed

- the terminal increment lignified
- the plants are well fertilized, without dried parts
- plants without leaves!!!
- the plants can be heeled in or stored for a short time (maximum 1 week)
- preferably wet and covered habitats





- protection against frost: partially sunk and mulched in
- protection against game
- *Picea abies* can be planted during this period only if the site gets covered with snow shortly after the planting and the snow cover lasts until the spring (till the end of the dormancy); or if the temperatures are expected above +5°C and the weather wet for a long period of time after the planting

## WINTER PLANTING - BARE-ROOTED PLANTING STOCK

- the temperatures must be above -5°C, the soil must not be frost
- broadleaves: planted by a planting bar
- in dormancy, early spring large-sized plants, larch, poplar

***MORTALITY AFTER AUTUMN PLANTING OF OAK 1-1 DEPENDING ON  
THE FUNCTIONALITY OF THE ASSIMILATION APPARATUS  
(date of planting: 10 October)***

<b>Plant</b>	<b>Mortality (%)</b>
Without leaves	5
Partially dried leaves	31
Green leaves	68

## SHORTENING THE ROOTS IN THE PLANTS WITH A TAPROOT

(general rules: diameter of the shortened root 6 mm maximum; do not remove more than 1/3 of the volume of the root system; the cut must be smooth and vertical)

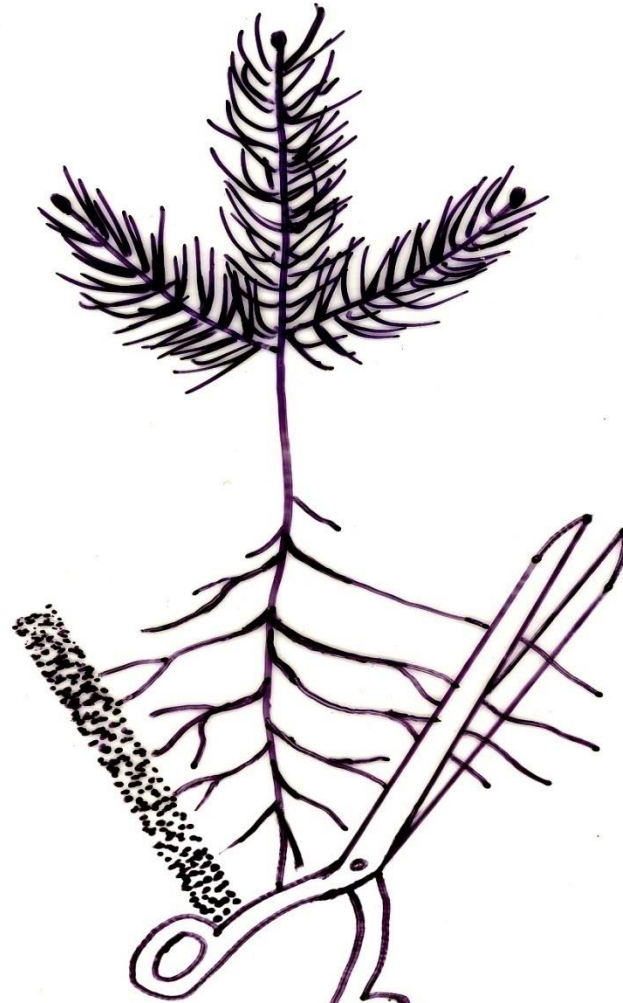



# SHORTENING THE ROOTS IN THE PLANTS WITH A SUPERFICIAL ROOT SYSTEM

(refer to the general rules)

Fir, Douglas-fir and lime's roots „don't like“ shortening

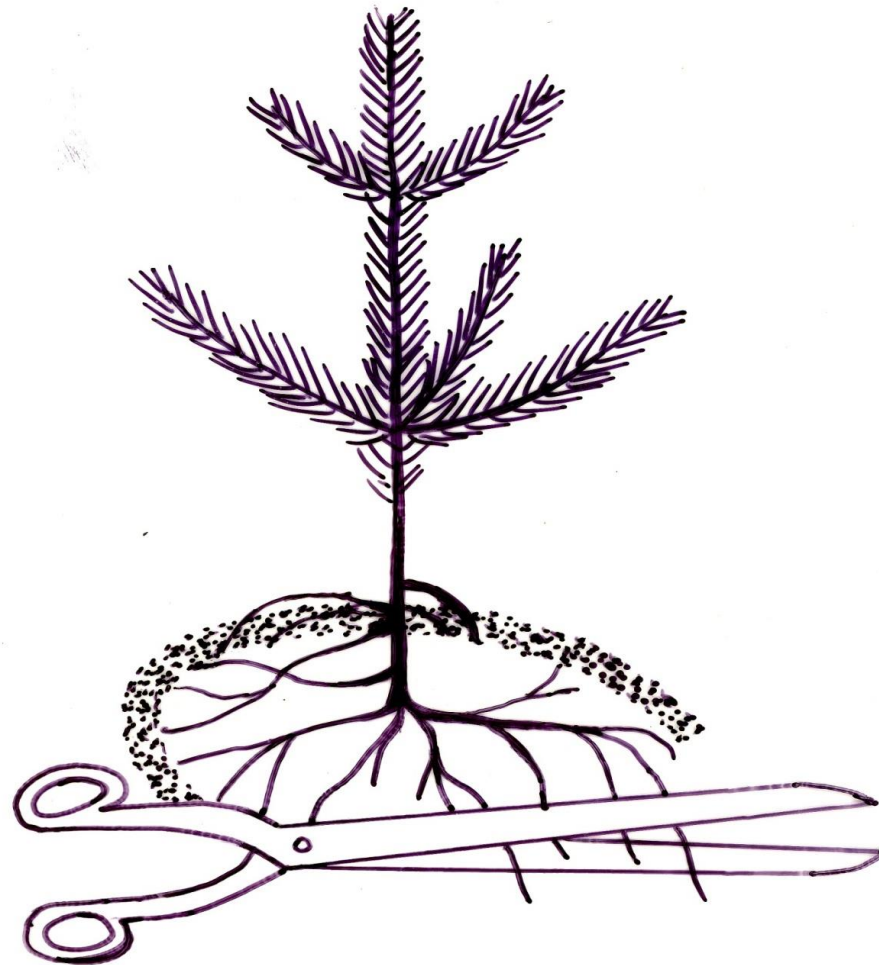

# **Avoid during planting:**

- **Root deformation**
- **Smoothed walls of the hole**
- **Compacted walls of the hole**
- **Air pockets in the hole**
- **Planting only into mineral soil or humus**
- **Dried roots**

# TYPES OF PLANTING OF BARE-ROOTED PLANTING STOCK

- Hole planting

The procedure for planting into holes with a hill

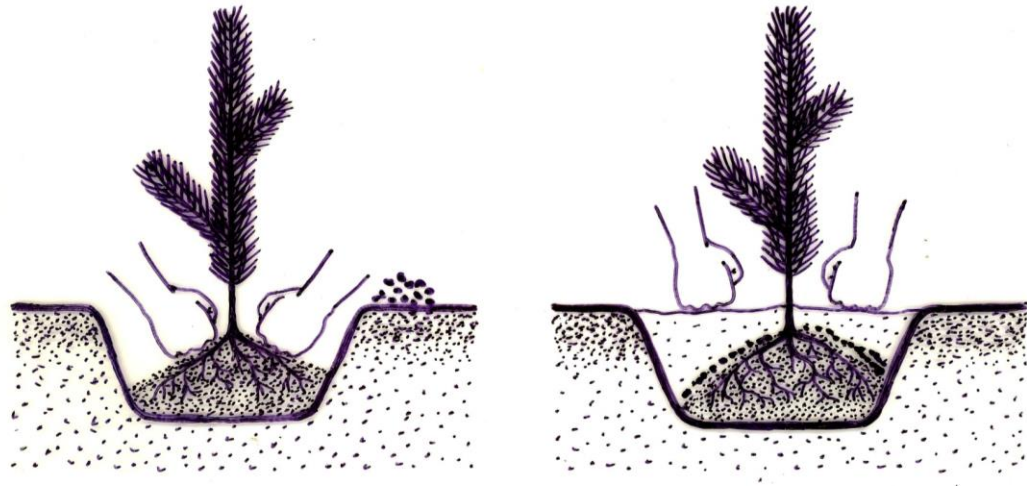

- *drought periods (modification)* - the so-called goat's back
- to the wall of the hole



# Correct planting (hole planting)

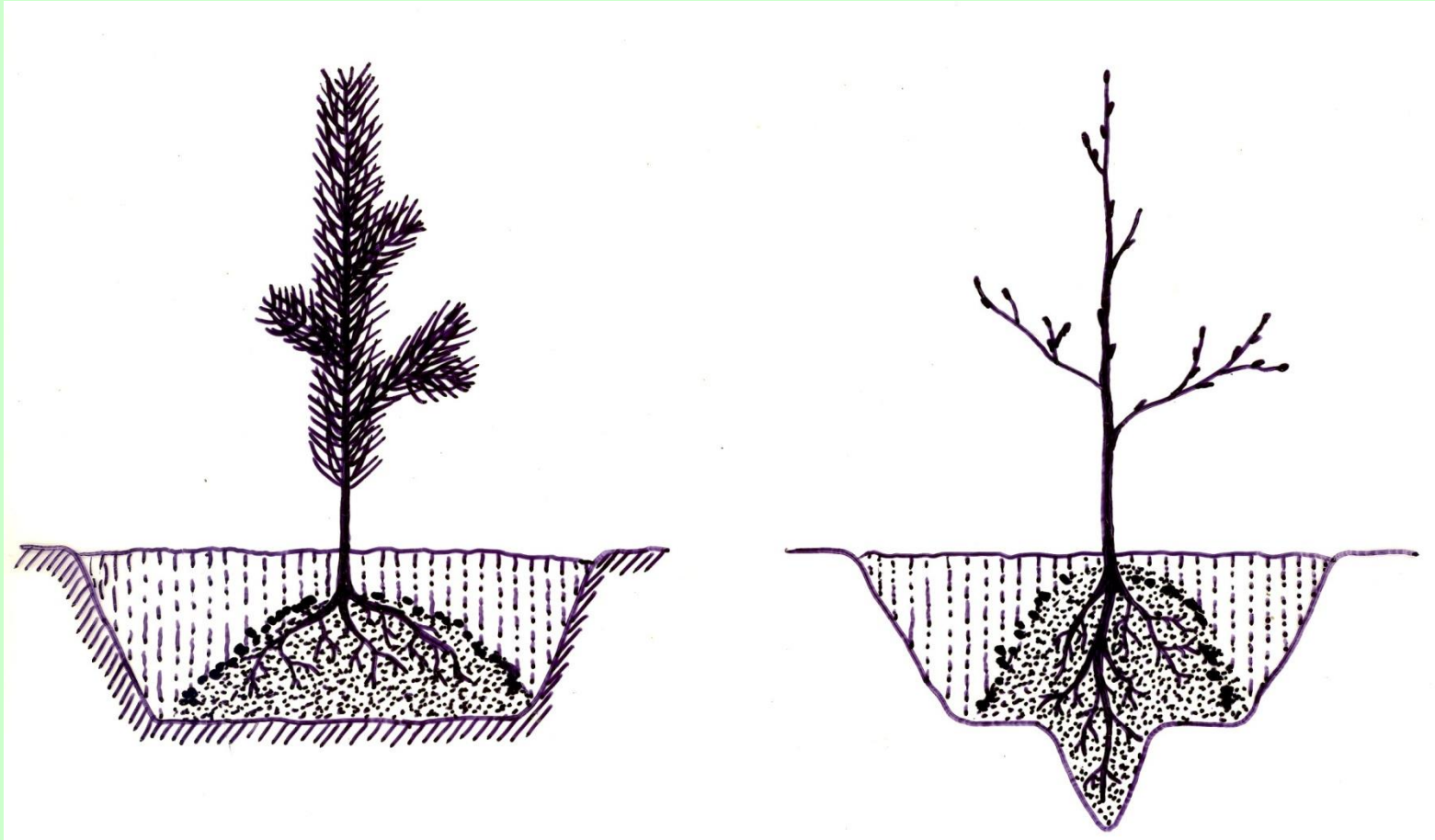

Broadly-developed root system ("hole-and-hill" planting)

Taproot

# Wrong planting

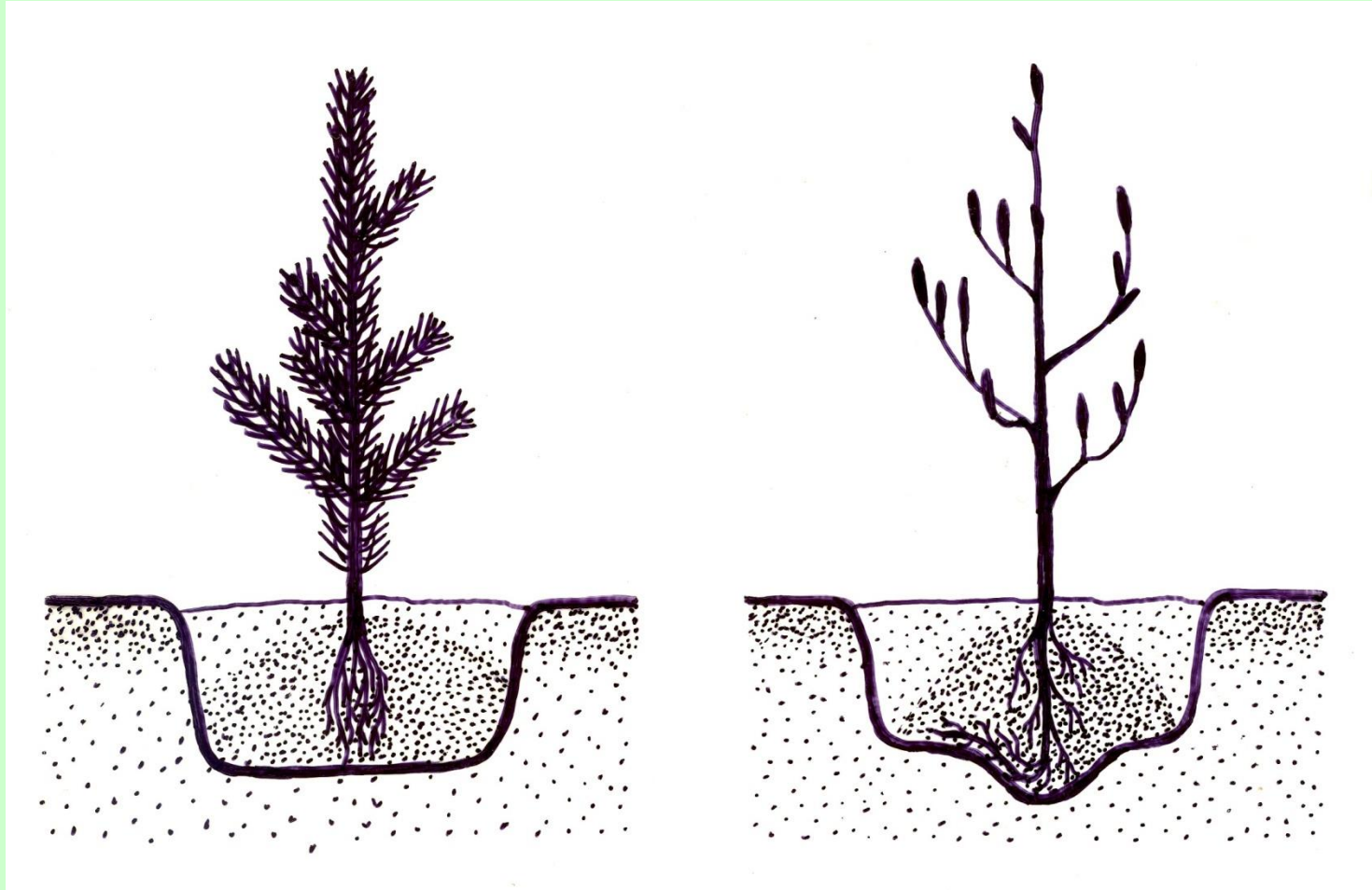

**Broadly-developed root system**

**Taproot**

# Planting methods according to the shape of the root system

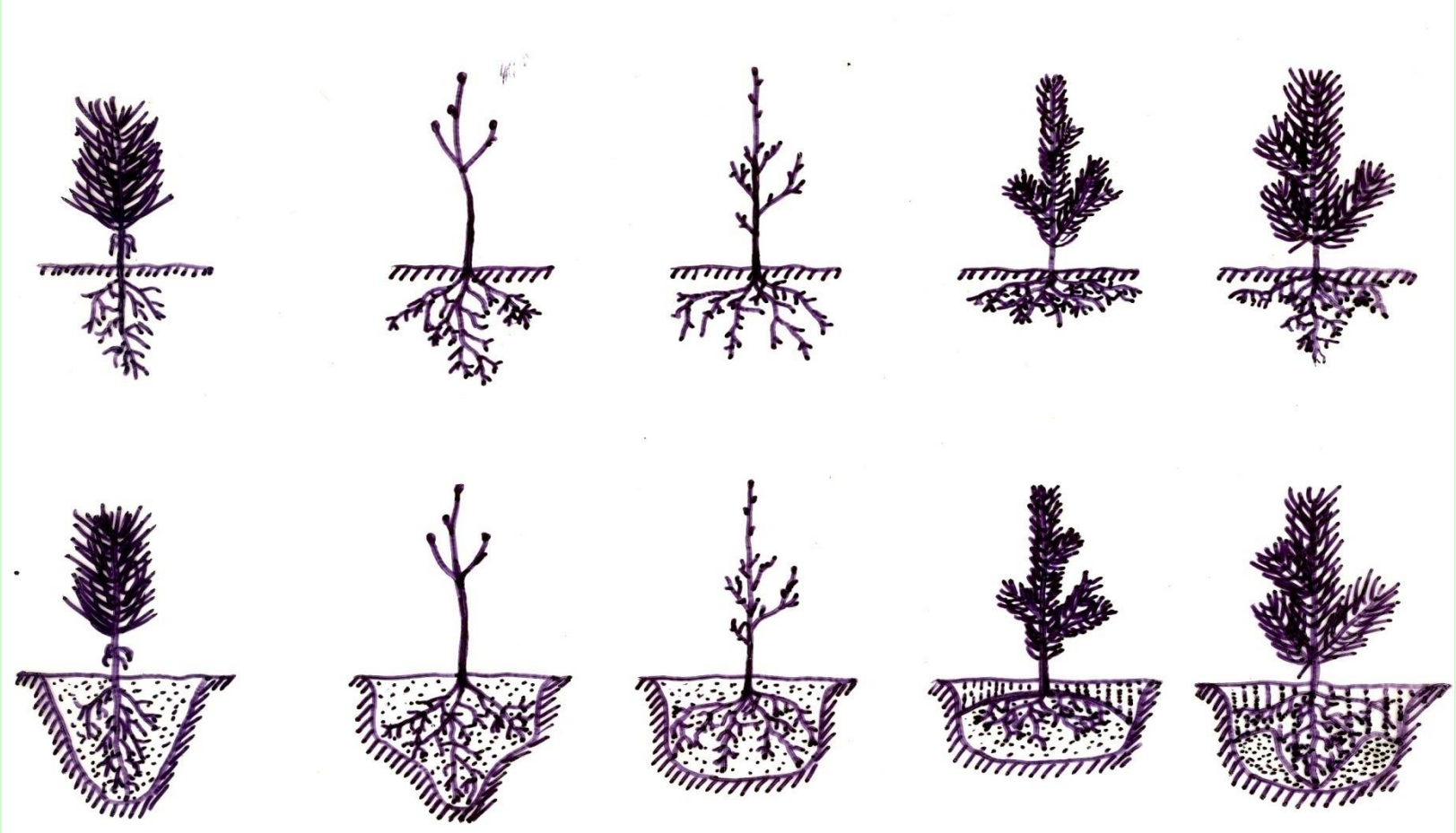

pine

wall-nut

alder

spruce

Douglas fir



**Axe-hoe**



# TYPES OF PLANTING OF BARE-ROOTED PLANTING STOCK

- slit planting
- athwart planting (under the hoe)
- angular planting
- corner planting
- cross-like planting
- planting with a shaped hoe (T-shape, M-shape)
- „cloche“ planting
- „cover-type“ planting

} also with L-hoe

„sod“ (type)





**Slit planting with  
a planting bar**





# MAIN RULES WHEN APPLYING THE MANUAL SLIT PLANTING METHOD

1. **Positives (compared to hole planting)**
  - ◆ faster and less laborious
  - ◆ ground water capillarity is not disrupted so much (the plant has more moisture during dry periods),
  - ◆ better contacts of the roots with the soil.

# MAIN RULES WHEN APPLYING THE MANUAL SLIT PLANTING METHOD

## 2. Negatives (compared to hole planting)

- ◆ cannot be used at all habitats,
  - ◆ cannot be used with all tree species and all types of planting stock,
  - ◆ always causes vertical flattening of the root system,
  - ◆ quick work may result in most serious deformations of the root system and considerable mortality of the plants.
- 
- A decorative teal silhouette of a mountain range is located at the bottom right of the slide.

### 3. Characteristics of the habitat

- Slit planting may be only used on the soil in which the entire planting bar can be pushed without difficulties. This means the soil with a degree of decomposability 1, 2 or 3 and soil of skeleton less than 30%; the soil must be deeper than the working area of the planting tool.
- Planting with a planting bar is not suitable in heavy soil or soil getting heavier after rain (smoothed walls are formed, the soil is compacted too much).
- Weed infestation should not be more than degree 0 or 1. If the weed infestation is heavier, it is necessary to remove the sod. Humus horizons are unacceptable, they must be removed from the planting area.



#### 4. **Use of tree species and types of planting stock**

- ◆ Slit planting is only suitable for planting stock with a tap root system or a anchored root system; it is absolutely unsuitable for tree species with superficial root systems or broadly developed root systems.
  - ◆ Slit planting can only be used if the root system fits into the slit – no deformation or broken roots (including the branch roots). The only acceptable type of deformation is coiling of the roots in the positive geotropic direction (perpendicular downwards).
- 
- A decorative teal silhouette of a mountain range is located in the bottom right corner of the slide.

- ◆ The length of the roots of the plants to be planted must be at least by 2cm shorter than the length of the working part of the planting tool!
- ◆ Slit planting is only suitable for seedlings and weak plants.



## 5. Procedures

- ◆ Slit planting is performed by two people – one person working with a planting bar (person 1), while the other handles the plant (person 2).
- ◆ When applying the slit planting method, not V-profile but X-profile slit is created (the planting bar does not rotate at the tip).
- ◆ The following operations are made before the planting (if necessary):
  - sod removal,
  - humus horizon removal,
  - roots shortening

- ◆ Person 1 pushes the entire planting bar (its working part) into the soil; pulling it towards and away, a slit is formed in the soil; after that the planter can be pulled out.
- ◆ Person 2 holds the plant to be planted in one hand and a 40-cm-long stick or narrow spade in the other hand; this person places the root system of the plants into the slit. The stick is used to direct the roots in the positive geotropic growth direction (all roots must be directed to this direction). The lower part of plant needs to be inserted into the slit; then, it must be pulled a little upwards so that the root collar is approx. 1 cm below the soil surface (this operation directs the roots to be growing in the positive geotropic growth direction once more). It is not permitted to rotate the plant! Then, the person 2 puts the stick aside and uses the same hand to pour organic mass onto and through the root system (which can be brought to the site, or the organic mass from the soil horizon can be used). Or, the stick may be used to compress the organic mass onto the roots better.



- ❖ After that, the person 1 pushes the entire planter tool into the ground approx. 6 to 8 cm far from the slit; pulling it towards and away, the person 1 stabilizes the slit. The first pull action must be directed towards in order to stabilize the lower part of the slit (if the person works too quickly and the lower part of the slit is not stabilized, air pocket will be formed and the plant will die). The planting bar can be twisted to both sides to establish a proper contact of all roots with the soil and eliminate air pockets in the soil. The soil should be compacted but it should not be compacted too much (otherwise too much air is pushed out). The person 2 holds the plant in their hand for the whole time.
- ❖ The newly created slit (the second one) must be stabilized by pushing the planter into the soil again; the third slit can be stabilized e.g. with the tip of the shoe. Open and non-stabilized slits allow water soaking in the soil but, on the other hand, they allow the soil get dried or frost through, which decelerates the growth of the roof system.

## 6. General notes

- Except for sandy soils, the critical factor is lack of oxygen so it is not recommended to sink the plants.
- Additional organic mass will considerably stimulate the growth of the roots and decrease the post-planting shock. Just add one handful of the organic material per slit. If the slit planting is used in heavier soil, more organic material should be added – up to the whole volume of the empty space (in this case, the organic material can be substituted with quality humic soil).
- Slit planting is absolutely unsuitable for containerized planting stock (for any type of containers).
- To accelerate the work and use the labour in a more efficient manner, it is recommended to set up work groups (working together), where the number of people working without a planting bar (persons 2) will prevail.
- Non-observance the described principles of slit planting can result not only in high mortality as such; the stands planted in improper manner will become seriously threatened as well.

**The working part  
of the planting bar**





**Planting bar**



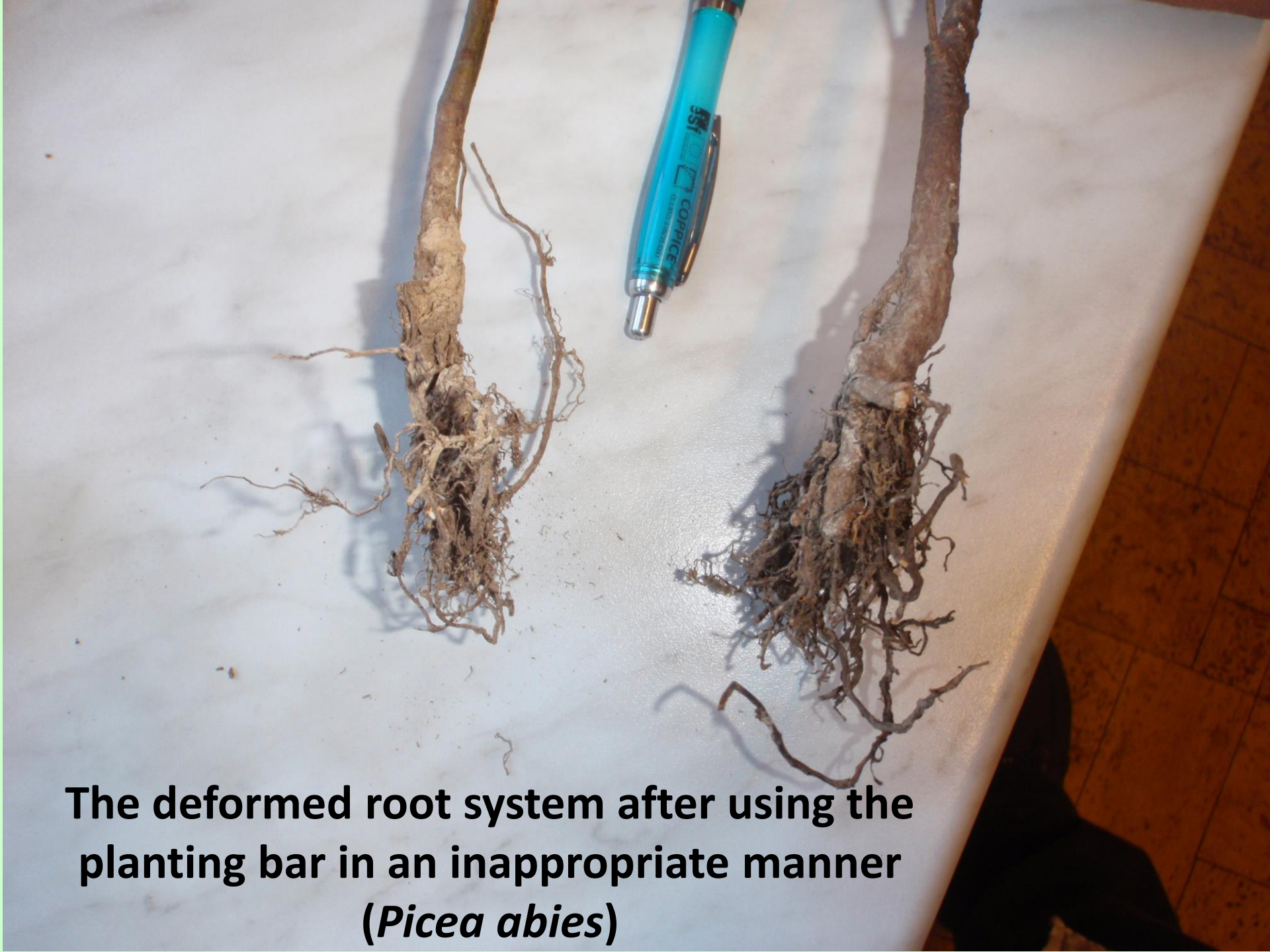

**The deformed root system after using the planting bar in an inappropriate manner  
(*Picea abies*)**

# Athwart planting scheme (the so-called “under the hoe” planting)

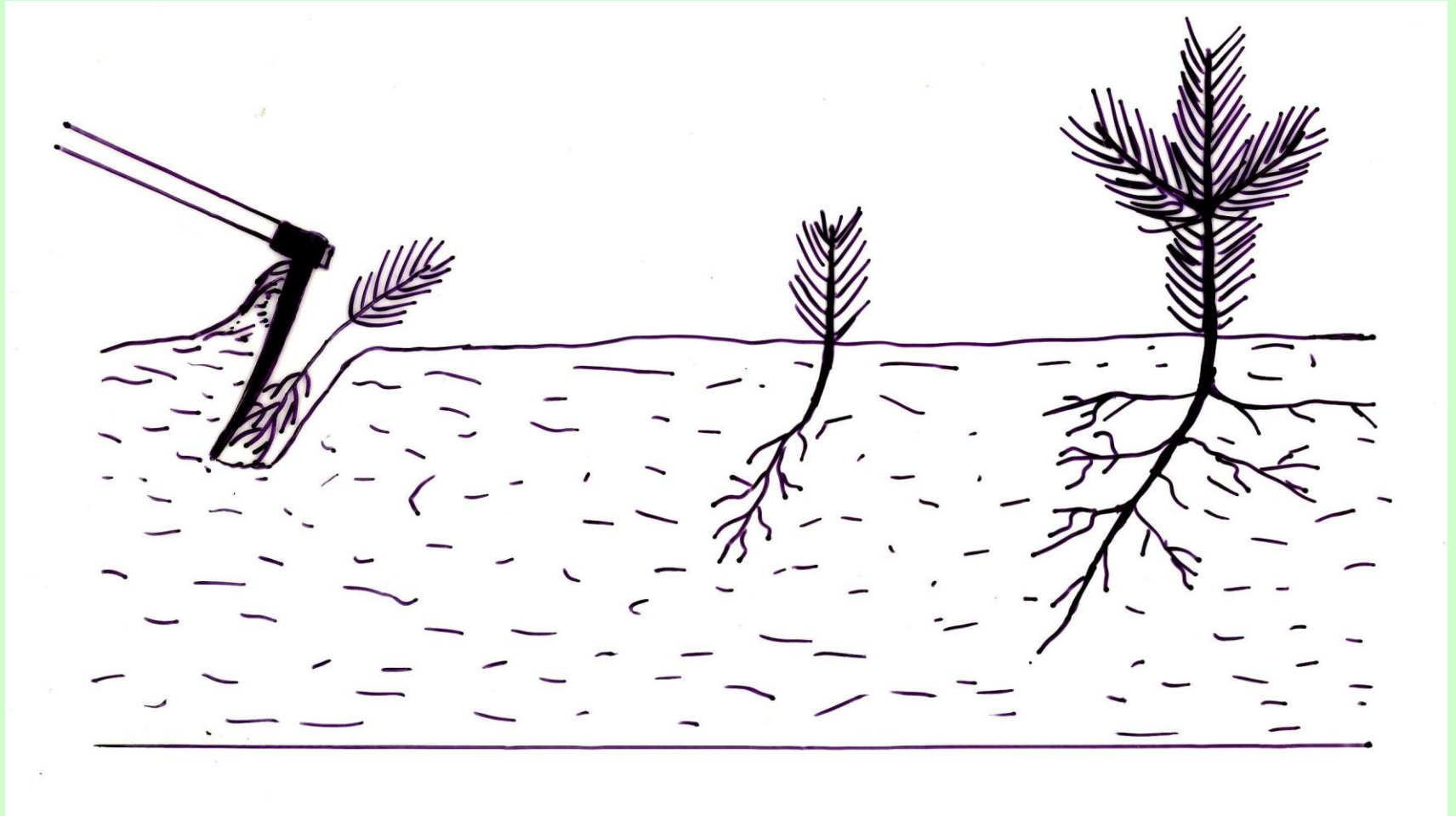

# Athwart planting

- Procedure: remove the weed (sod) and dig the hoe into the soil slantwise; after that, pull the hoe towards your body and place the plant into the slit; the root system must be spread properly at a depth of 2 cm below the soil surface. Pull the hoe out and compress the slit with your shoe.
- The angle between the slit and the soil surface must be more than 45° otherwise the root system becomes permanently deformed.
- The length and the width of the root system cannot exceed the length and the width of the working part of the hoe.

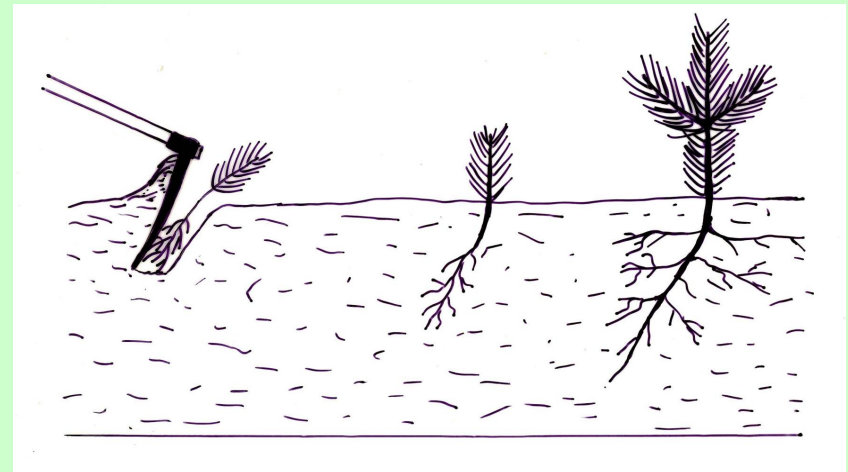

# Corner planting

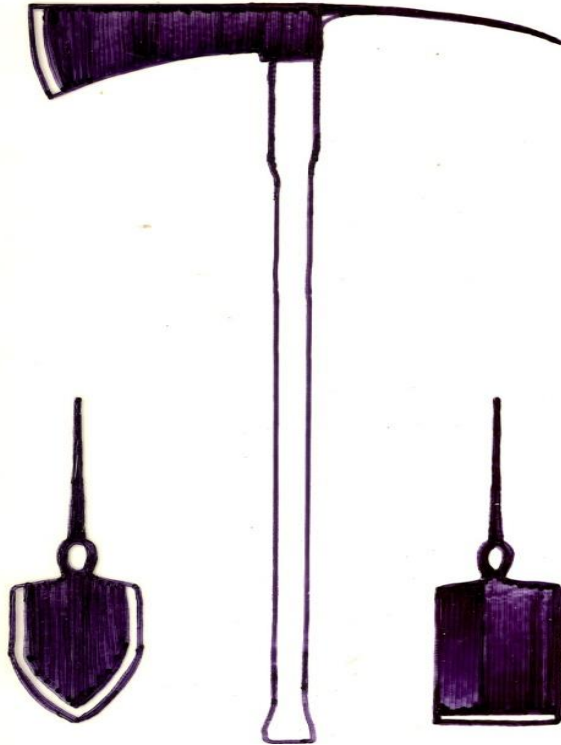

**Tools**

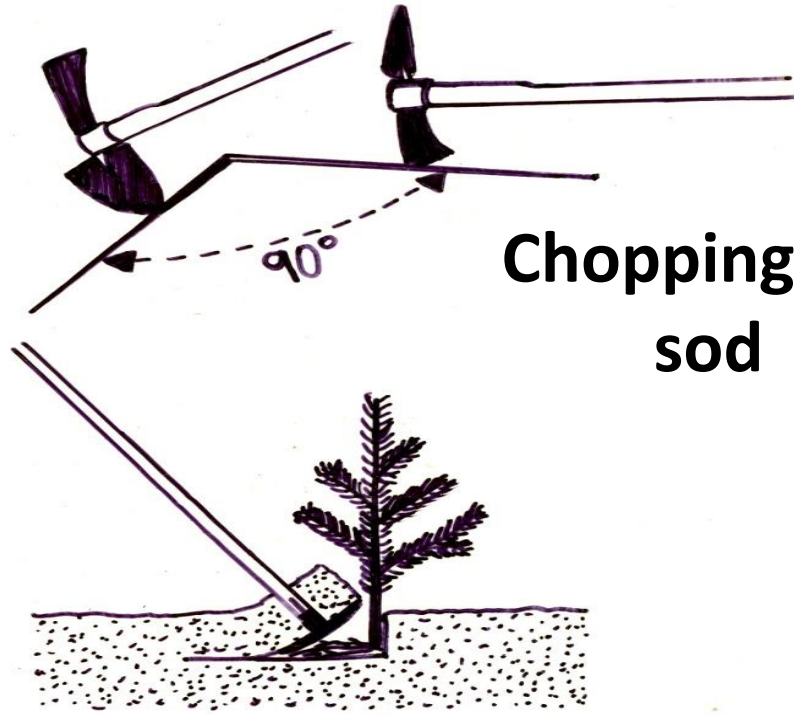

**Chopping the sod**

**Turning the sod off  
to place the plant**

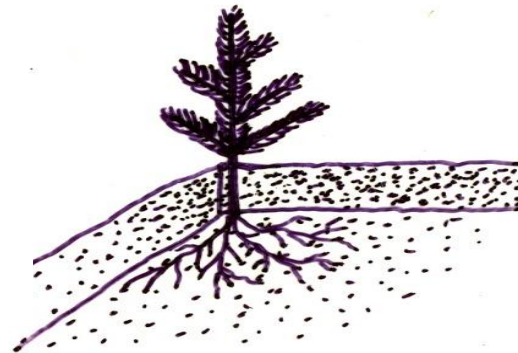



# Angular planting



The procedure is the same as in the corner planting but the plant is not put into the corner but onto the wall of the sod; by angular planting a half of the root system is deformed: by corner planting three quarters of the root system are deformed.

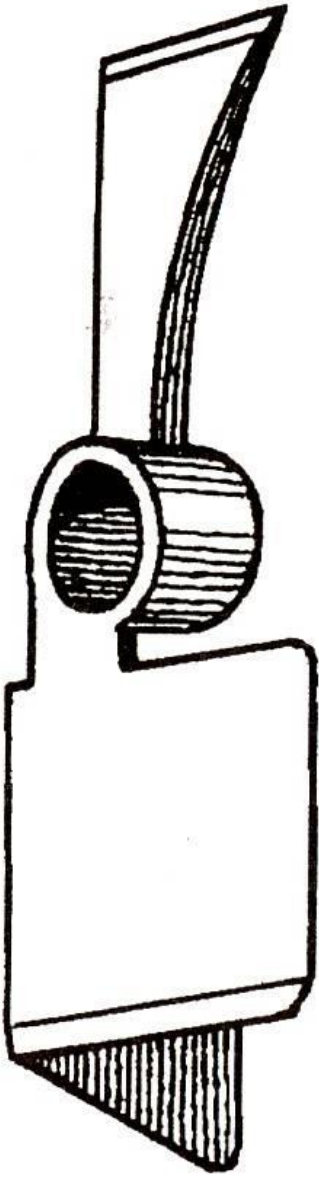

L-hoe

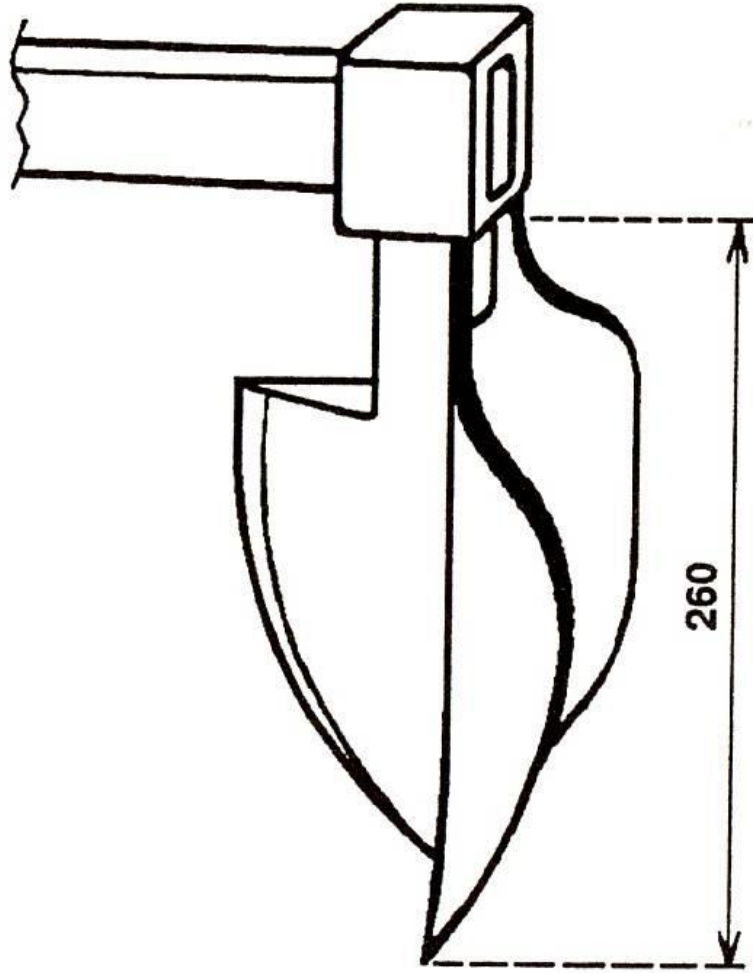

T-hoe

# L-HOE

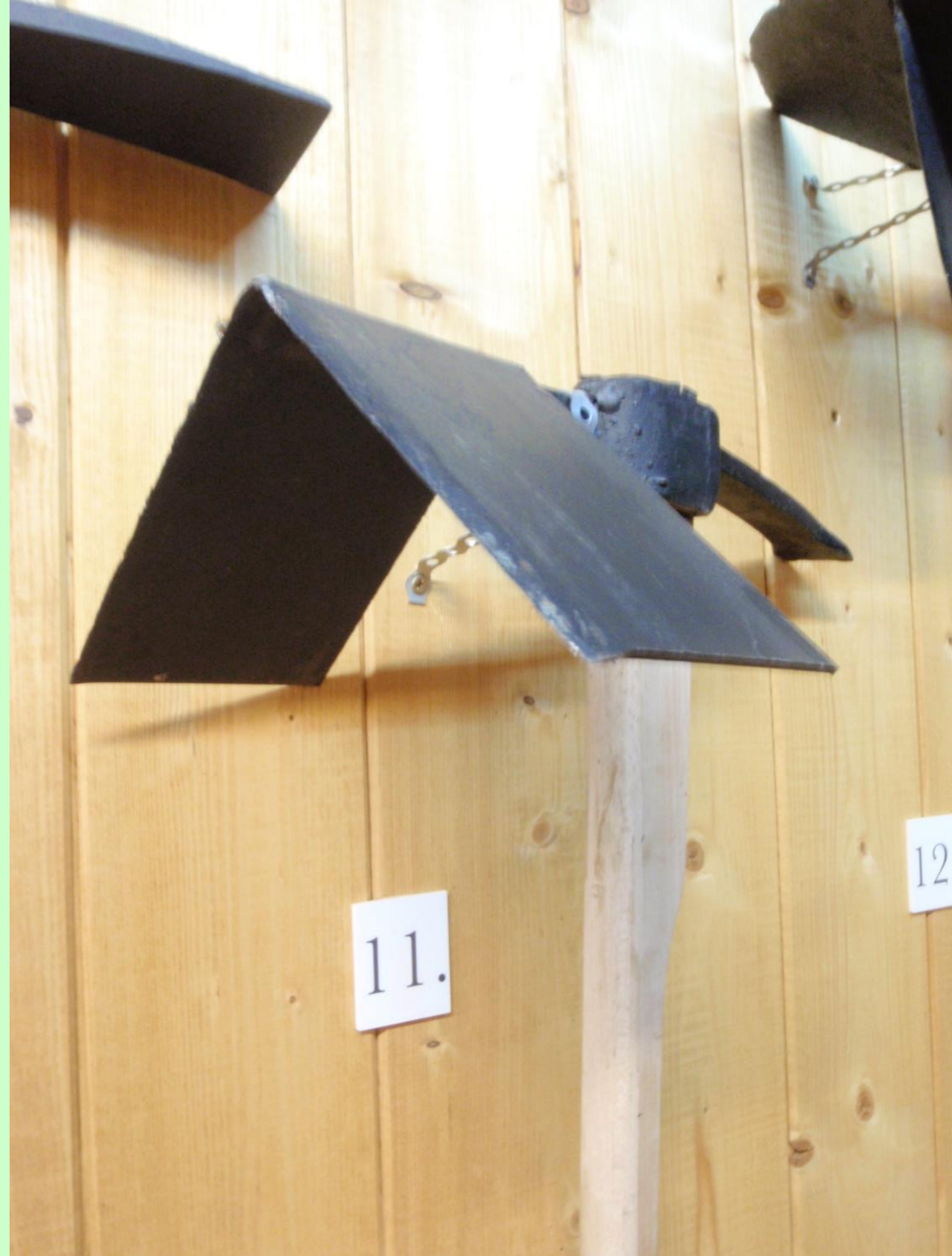

# T-HOE





# Cross-like planting

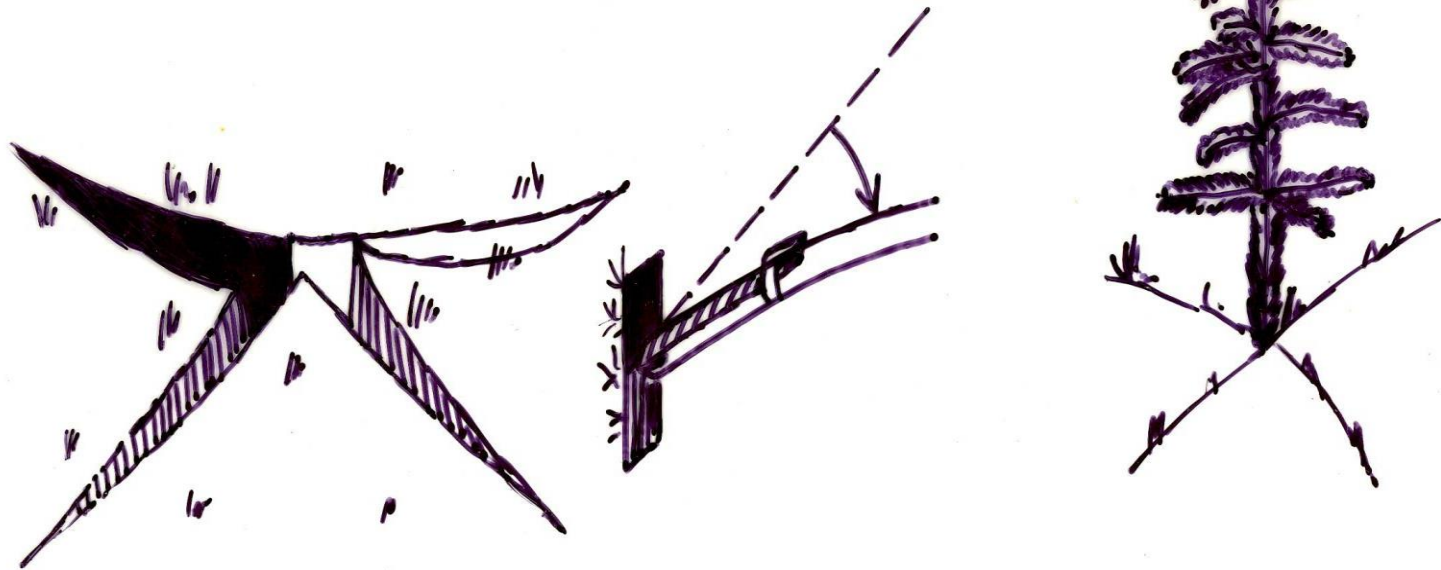

# Cover-type planting (elevated planting)

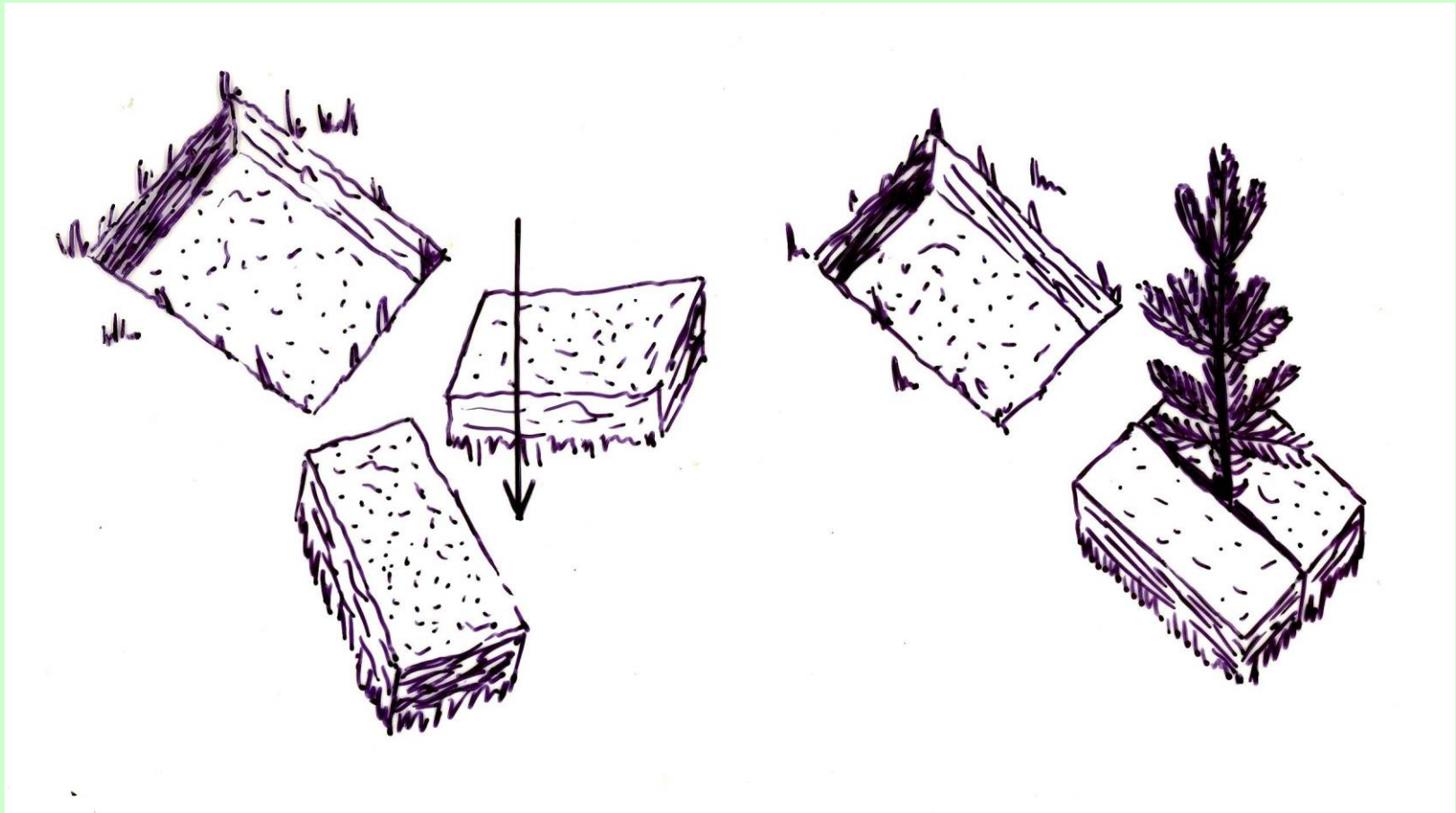

# Cloche-type planting

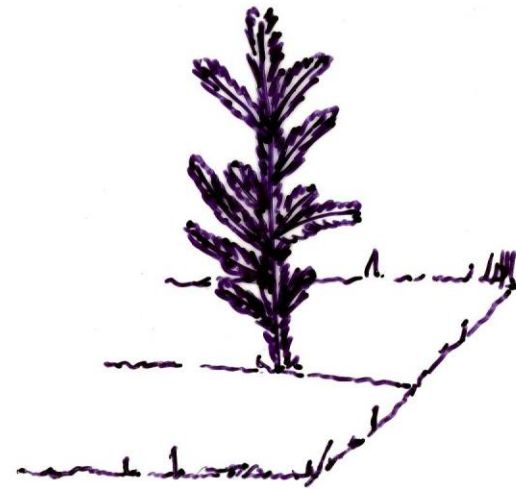
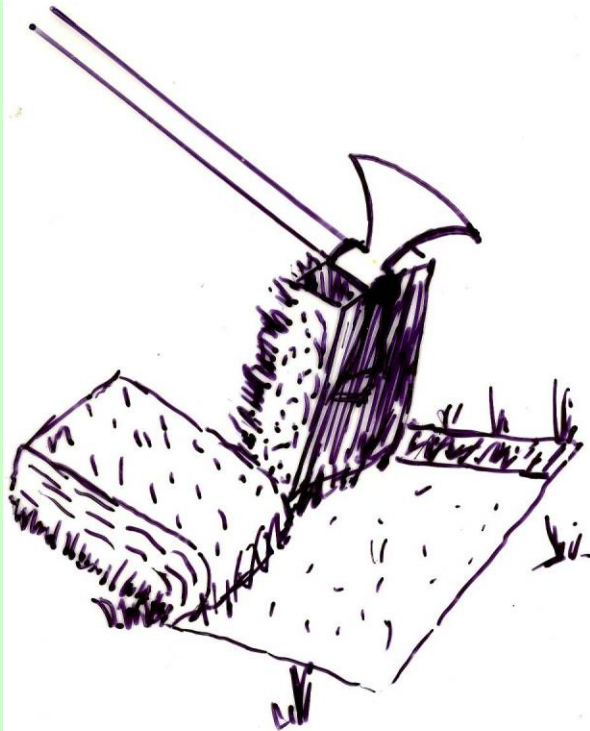

**M-HOE**





# **TYPES OF PLANTING OF BARE-ROOTED PLANTING STOCK**

*(continue)*

- with a condensation hole
- slit-hill type
- “pancake” type
- “tuft” type
- double planting
- triple planting
- wedge type
- chimney type
- shot-out holes
- pocket type
- with a triple-blade planter
- Rhoden method
- zone type (slopes) - terrace type

# The Rhoden type of planting

- This is a method between the slit planting and the hole planting. The procedure is shown in the picture. You need a special type of hoe (the blade is offset and the angle between the blade and the handle is approx.  $110^\circ$ ). Two persons need to be involved.

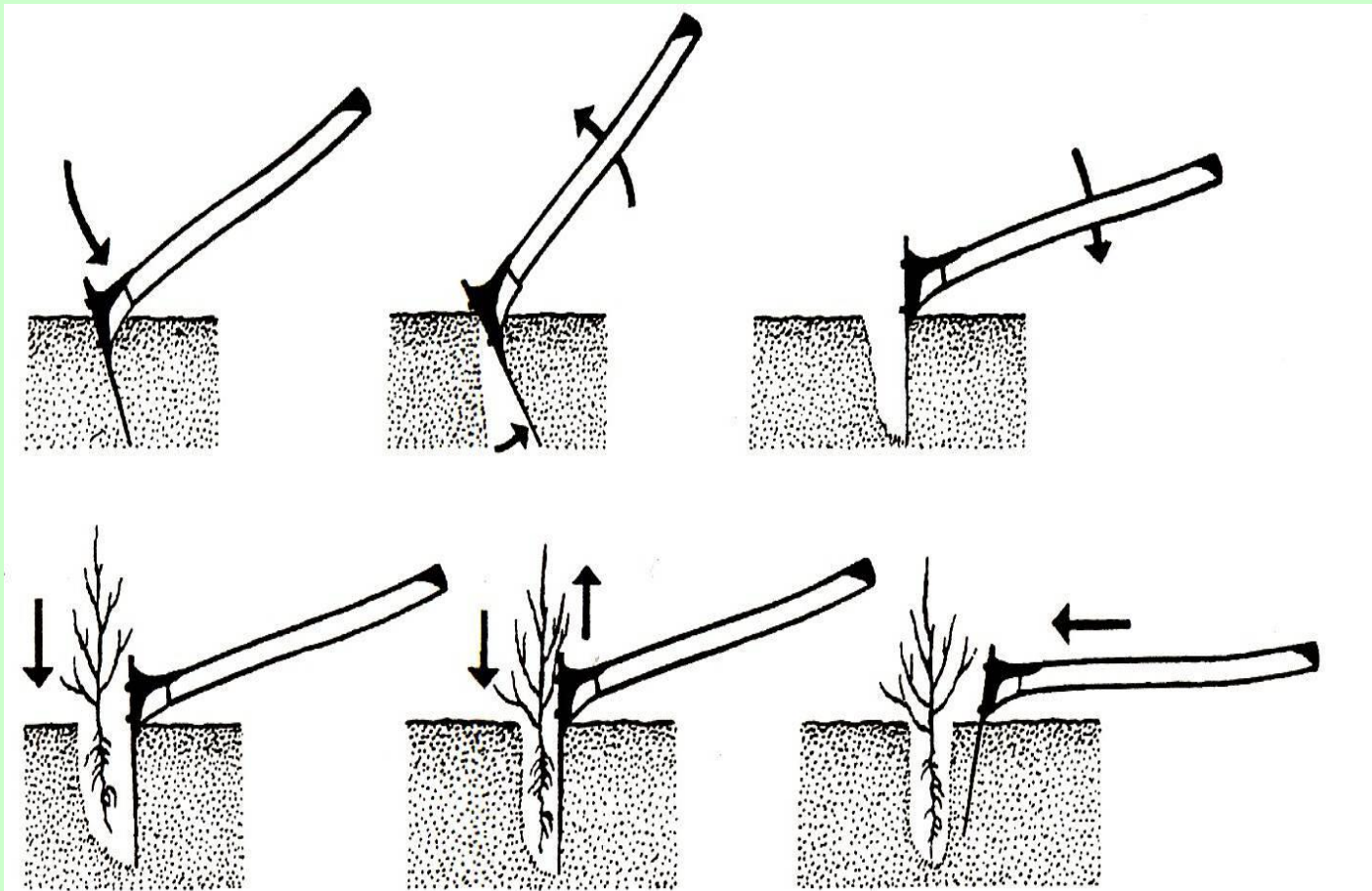

**The hoe used for the Rhoden planting**





# Zone type (slopes) - terrace type of planting





## Elevated planting (hill type)

Elevated planting is used if the plant should be quickly moved from a zone with a negative factor near the soil surface – frost, weed, water.

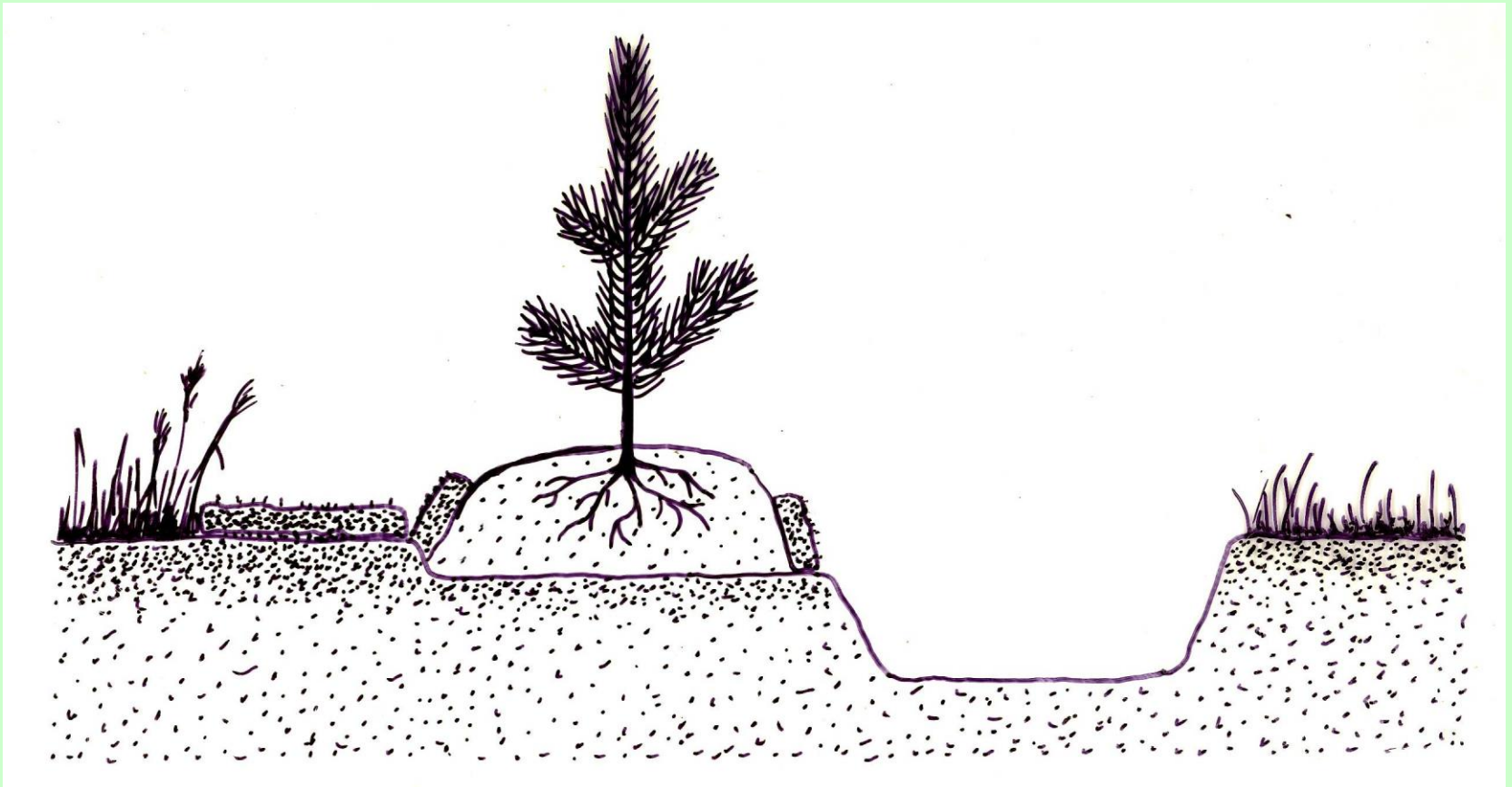

## Elevated planting (hill type)





Elevated planting (line type)





**Elevated planting (line type)  
– several years after planting**





## Preparation for ridge (wall) planting

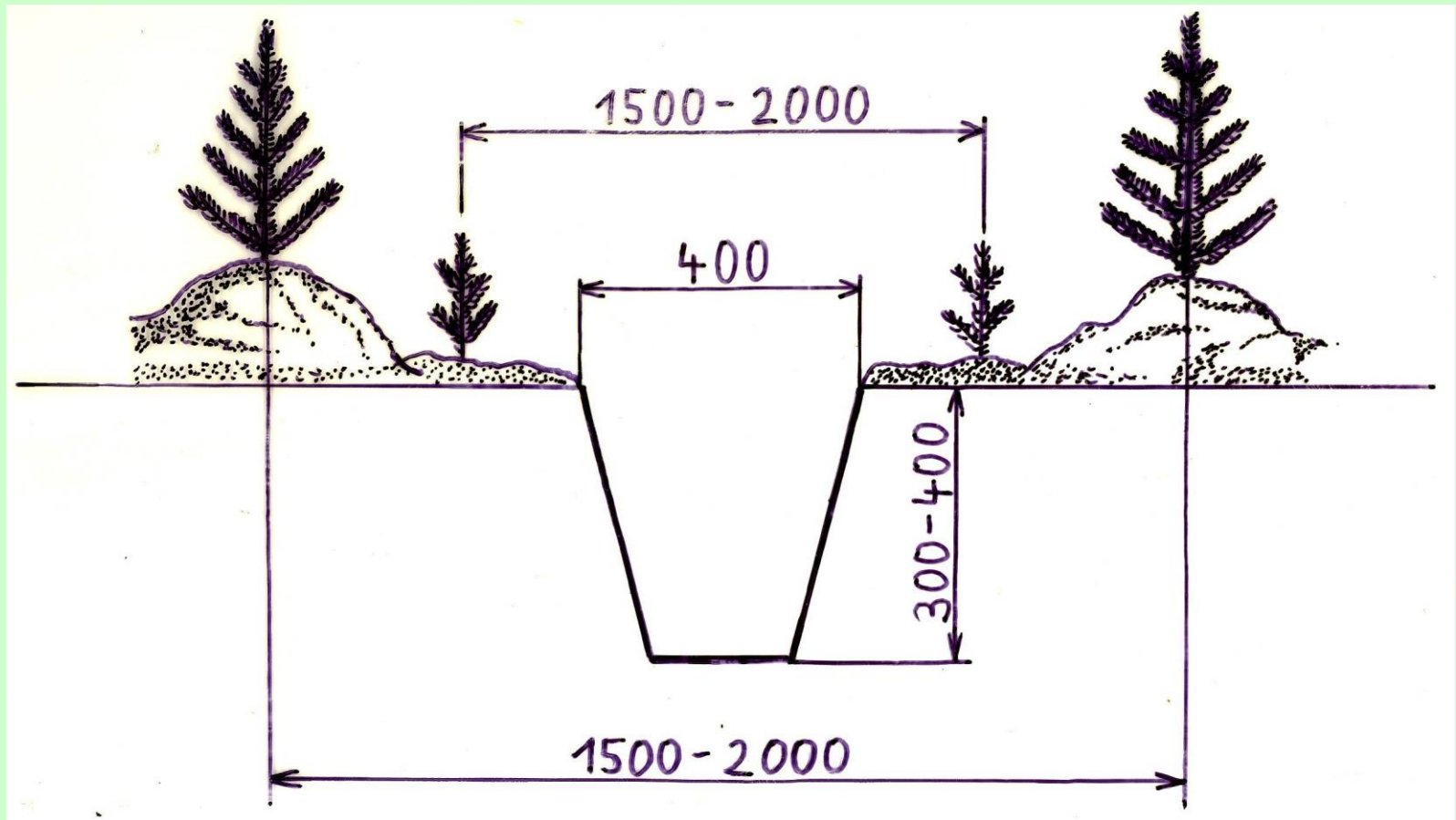



# USE OF MACHINERY

## *Planting machines*

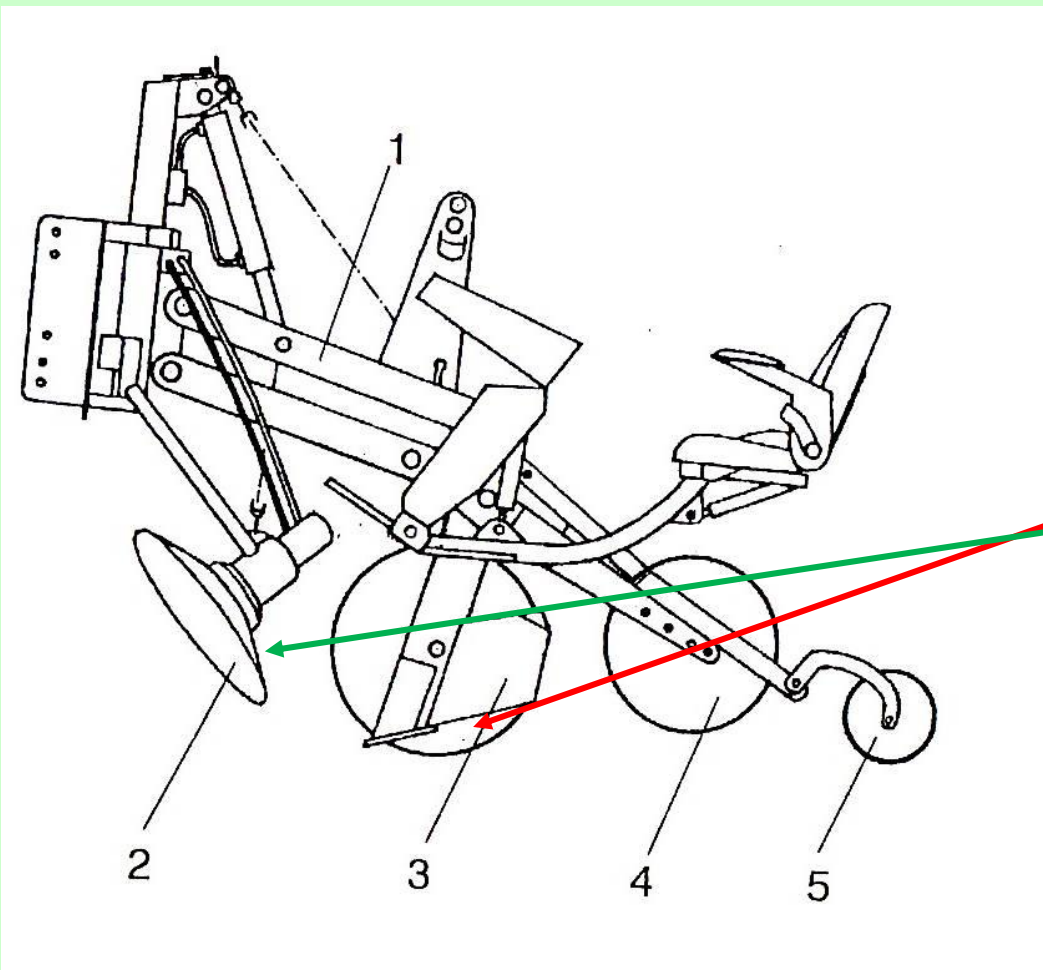

- **Slit (furrow) planting machine**
  - **slit made by the plough blade**
  - **slit made by the cutter**

**(the principle = slit planting)**





Furrow planting machine



# Furrow planting machine

# Earth augers

- manual, self-propelling, carried
- principle – hole planting
- these machines can throw the soil out of the hole; or they can remove the sod out as well





# Preparation of soil by earth auger for hole planting

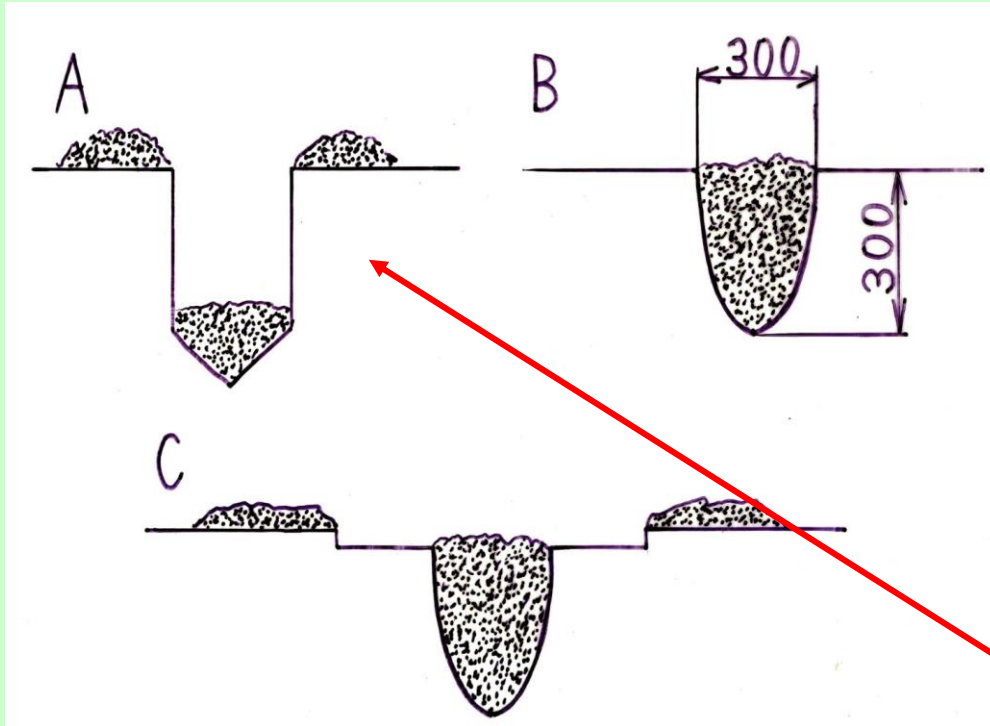

**A - spiral drilling bit**

**B - heart-shaped drilling bit**

**C - earth auger with spot maker**

**Drilling bit size: min. 1.5 times the diameter of the root ball of the containerized plant**



# Hole planting with an earth auger

# Hole planting with an earth auger behind a tractor (among others - types of planting)





# Machines for wounding of soil

- Instead the drill, the fixed blades or discs rotate
- result – loose soil

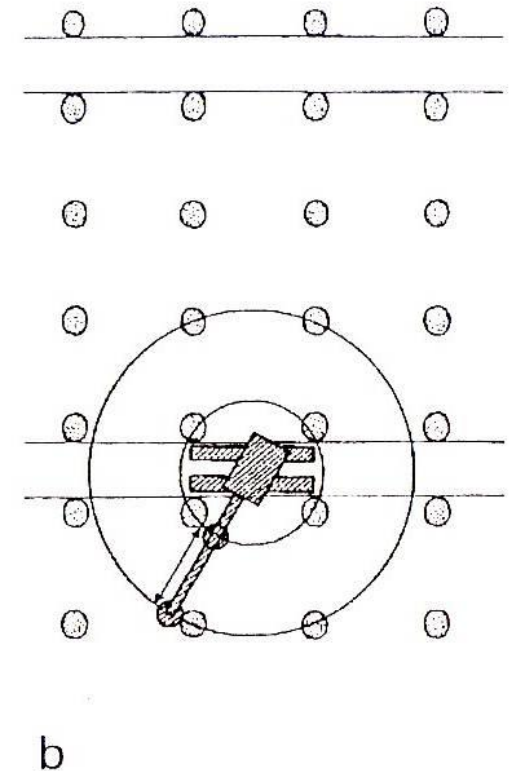
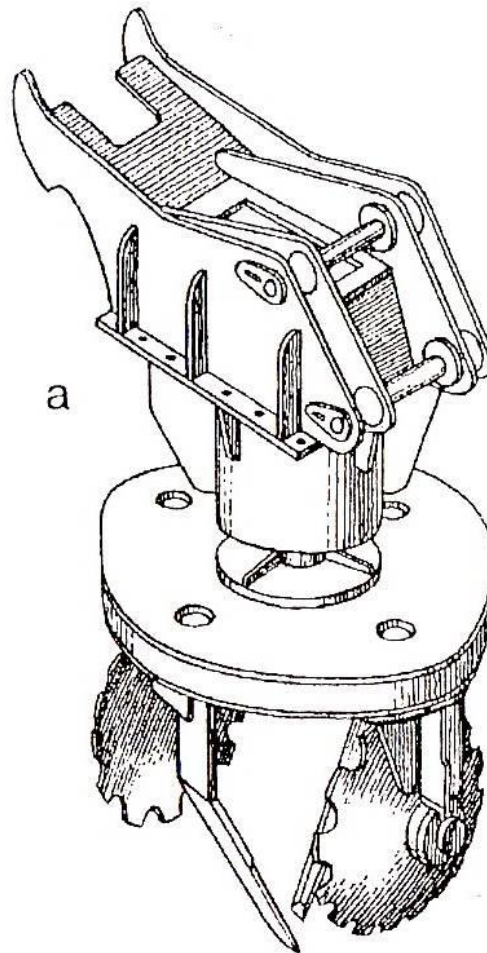

# Wedge excavator

- only when planting large-sized plants

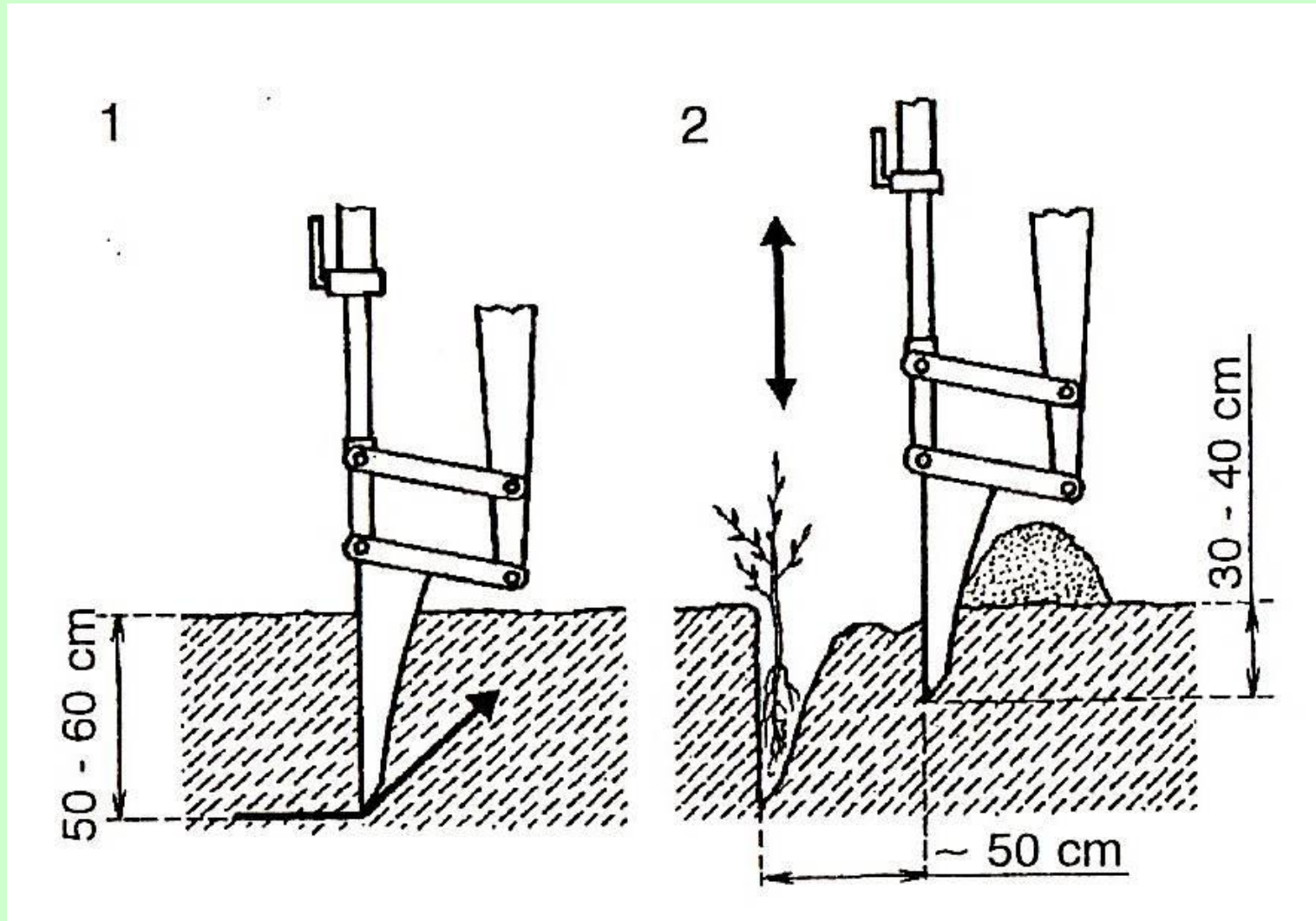

# Transport of bare-rooted planting stock while planting

- The planting stock must not get dried (the root system must be wet all time) and must be protected against mechanical damage
- Water is needed when planting
- Moving unprotected plants (e.g. a bunch of plants) is unacceptable
- It is recommended to use PE bags and pull them on the ground
- “Planting baskets” are useful too
- Other options: special textile and plastic bags
- Plastic (or metal) buckets are not recommended
- At the area to be planted, it is necessary to maintain a reserve equal to 30 minutes of planting (maximum)





**“Planting basket” covered with a wet textile**





**“Planting basket” with wet material on the bottom**





# Textile planting bag





# Planting bag





# Plastic bag usable for planting









**THERE IS A STANDARDIZED SIZE OF  
THE HOLE FOR EVERY TYPE OF  
PLANTING STOCK!**

- **PLANTING OF CONTAINERIZED PLANTING STOCK**
  - **Smoothed wall, air pockets or compacted soil are not acceptable**
  - **The root ball must be covered with approx. 2 cm of the soil**
  - **Small volume of the root ball (less than 0.5 l)**
    - **planting tube (Pottiputki)**
    - **hollow container seedling dibble**
    - **filled container dibble bar**
    - **planting spade (hole planting)**
    - **hole planting**
  - **Root ball of soil over 0.5 l – hole planting**

# Pottiputki planting tube





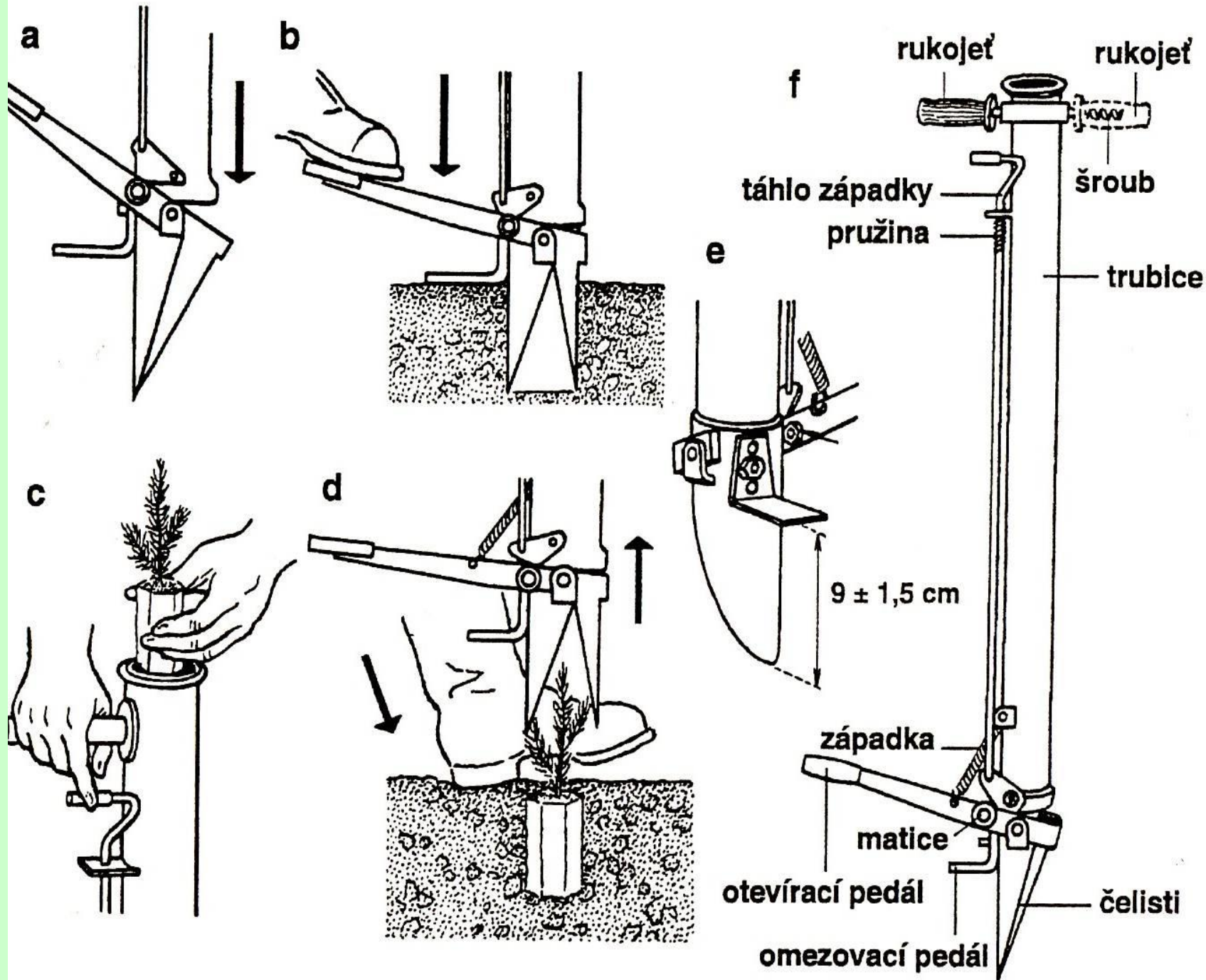













# Hollow container dibble bar





# Hollow container dibble bars





# Fill container dibble bar

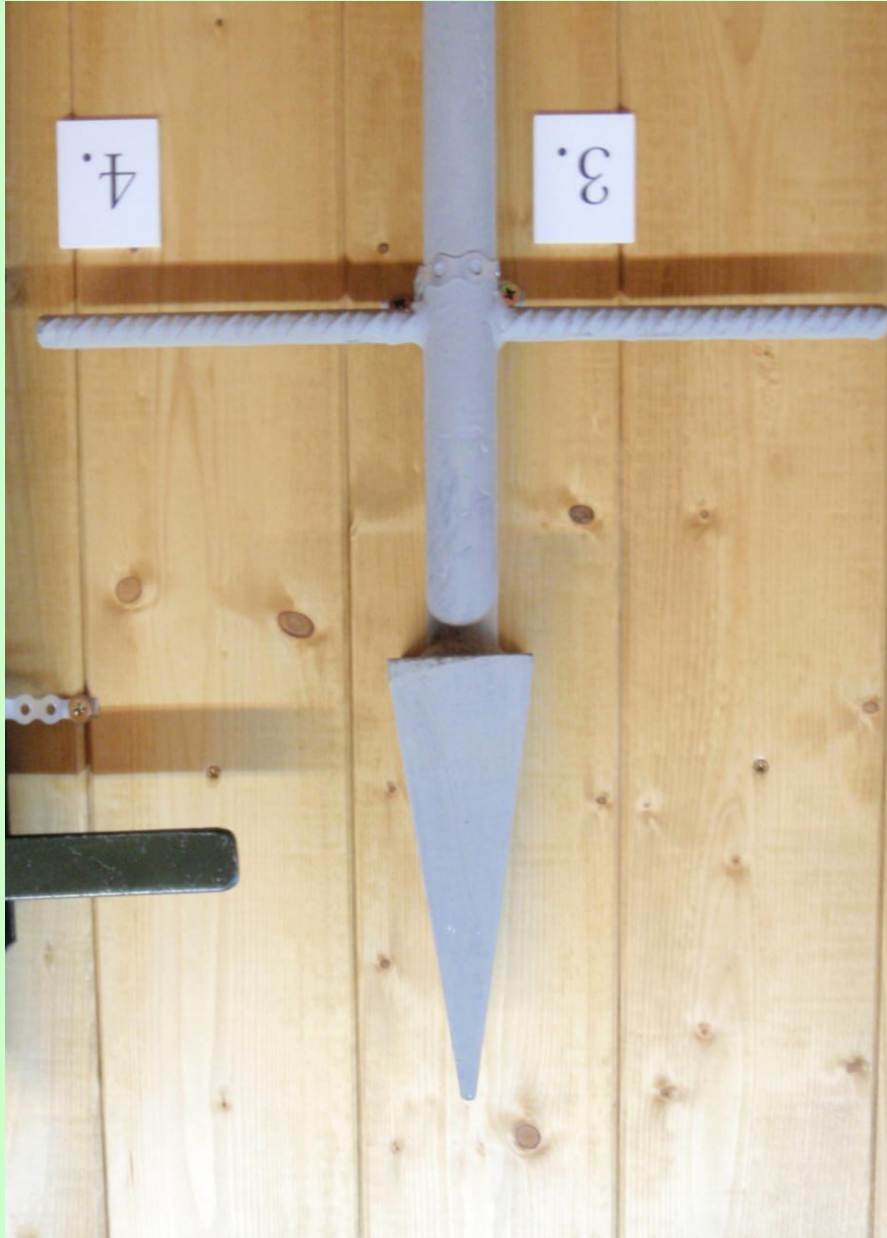

**Planting bar, hollow and fill container dibble bar  
(from the left)**





# Hollow spades

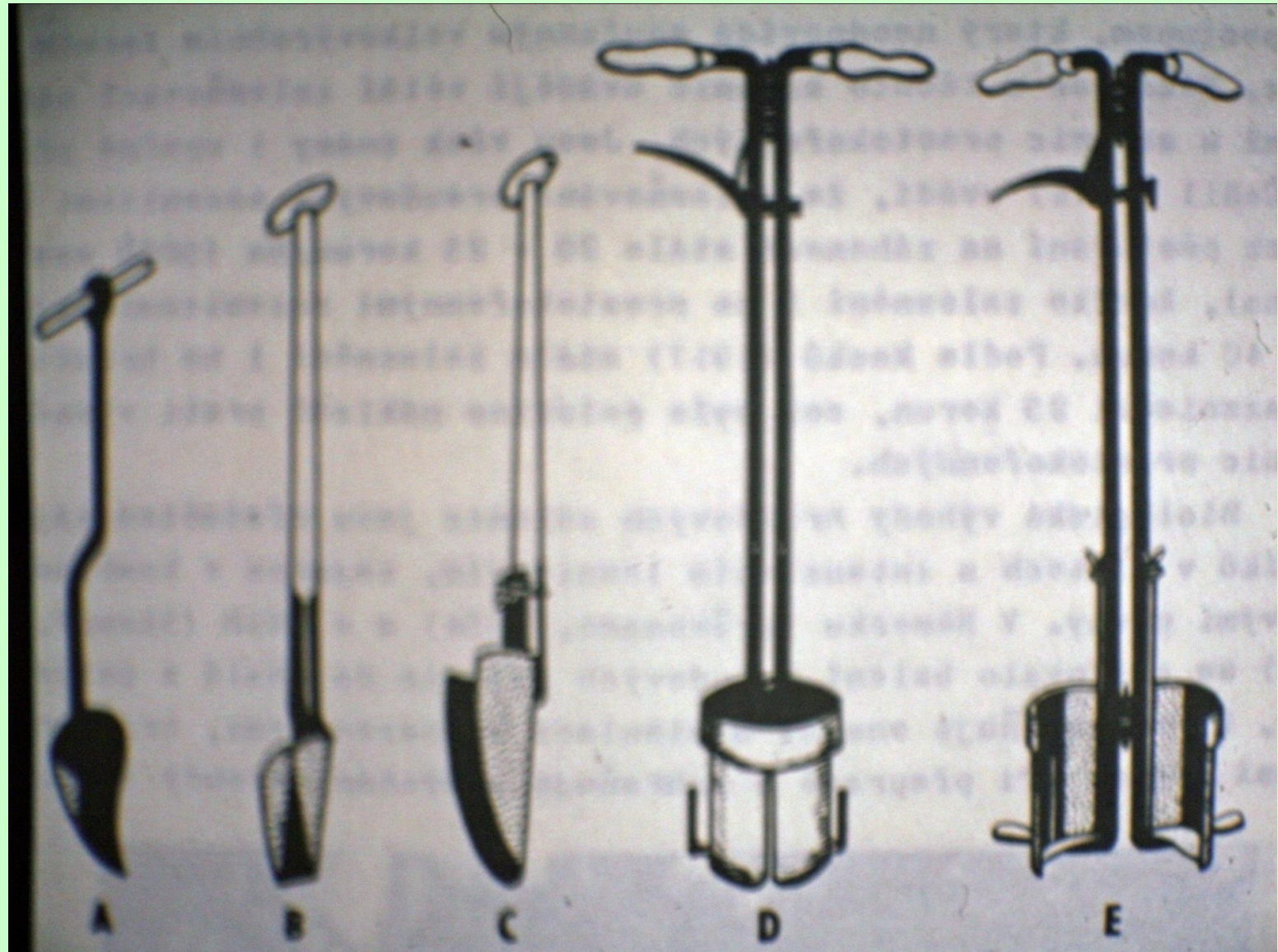



# Half-round spades





**1. Tear off (remove) the sod with the hoe-like part of the half-round spade**





## 2. Push the half-round spade into the soil





### 3. Pull out the half-round spade out, together with the released soil





## 4. Put the plant in the emptied space











# (Automatic) planting machine





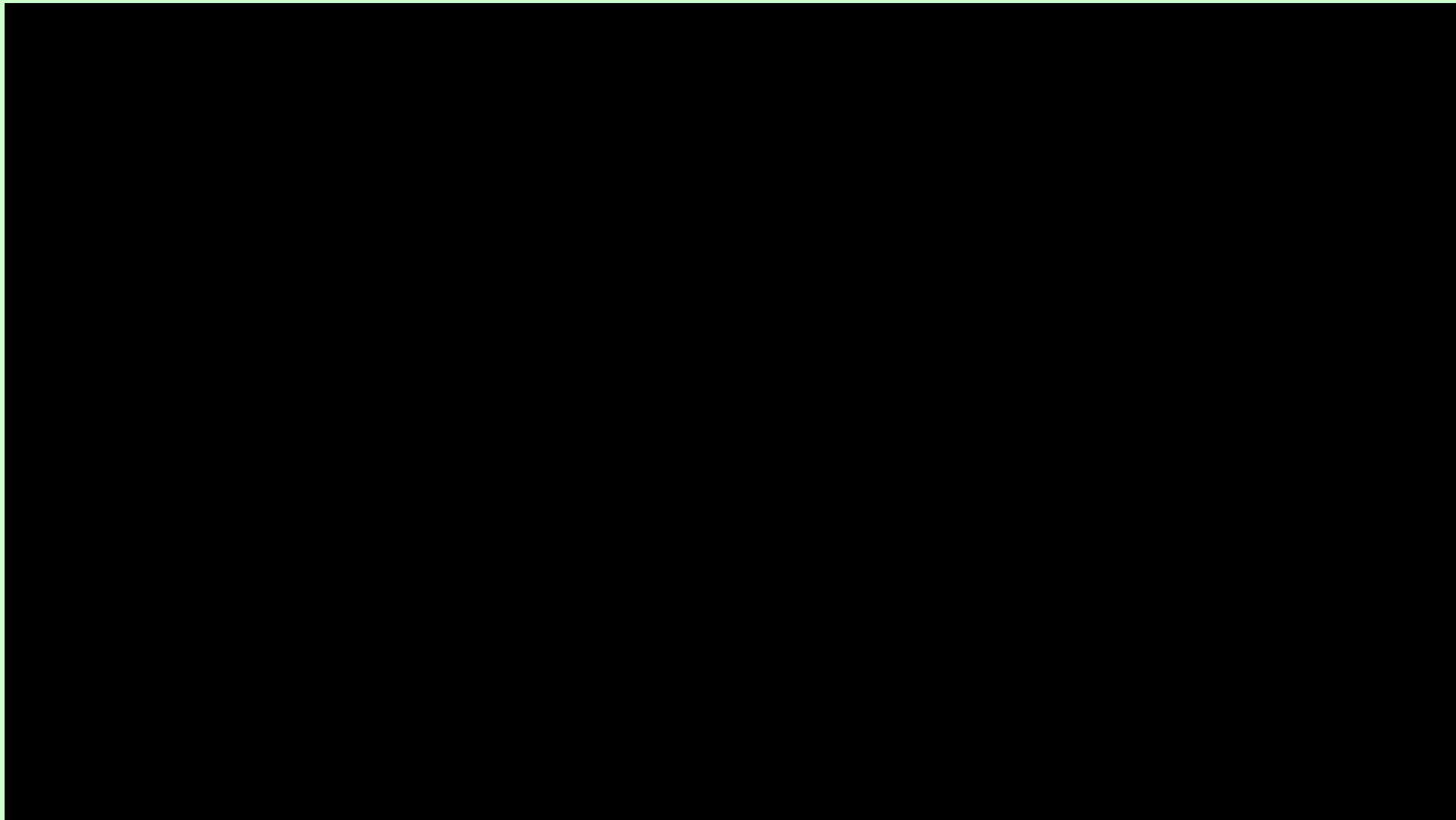

***ESTABLISHMENT OF  
MIXED FOREST STANDS***



**optimum**

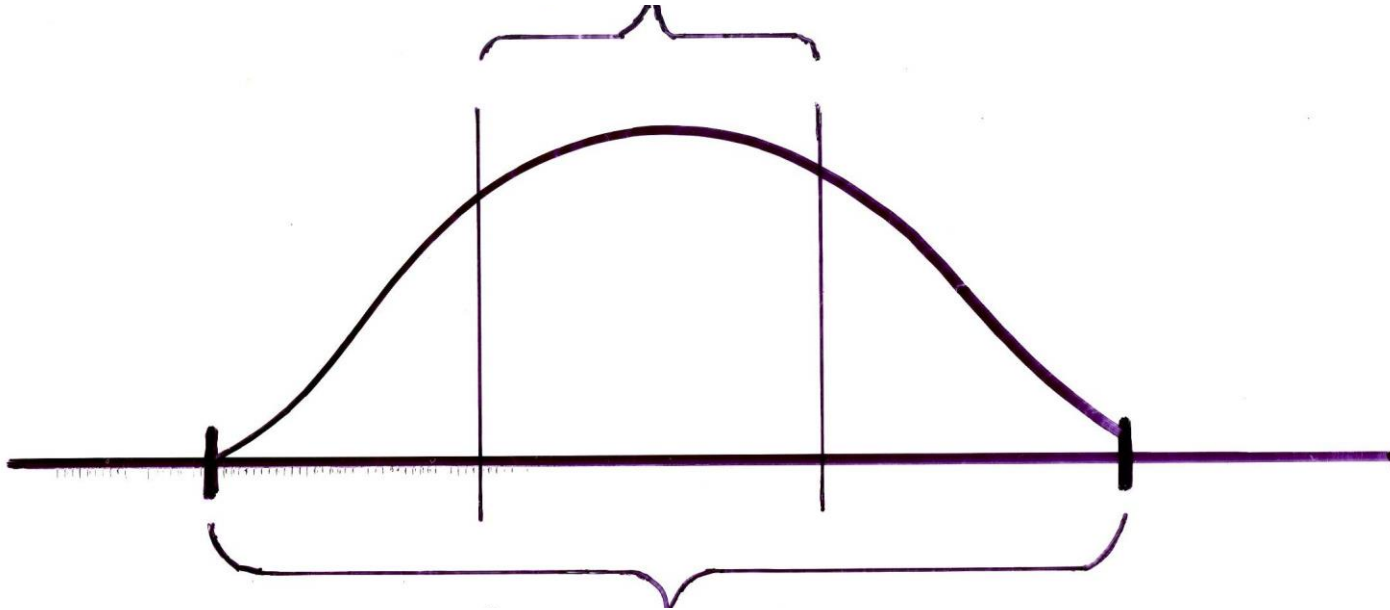

**eco-valence**

pine

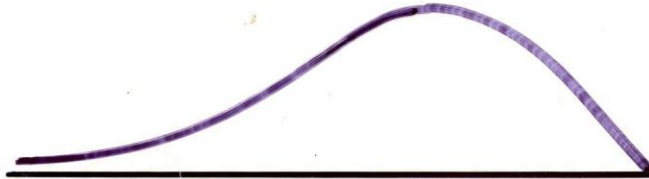

mountain  
pine

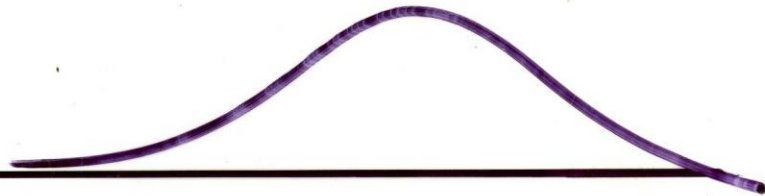

European larch

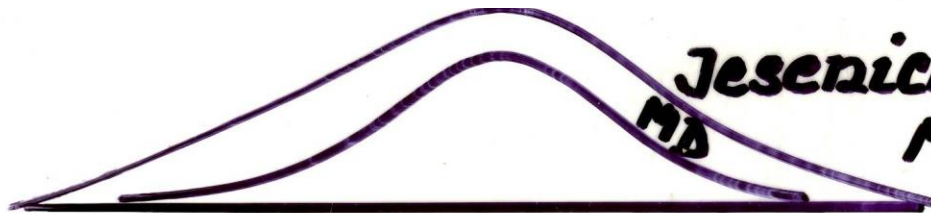

*Jesenický ekotyp*  
MD

MD

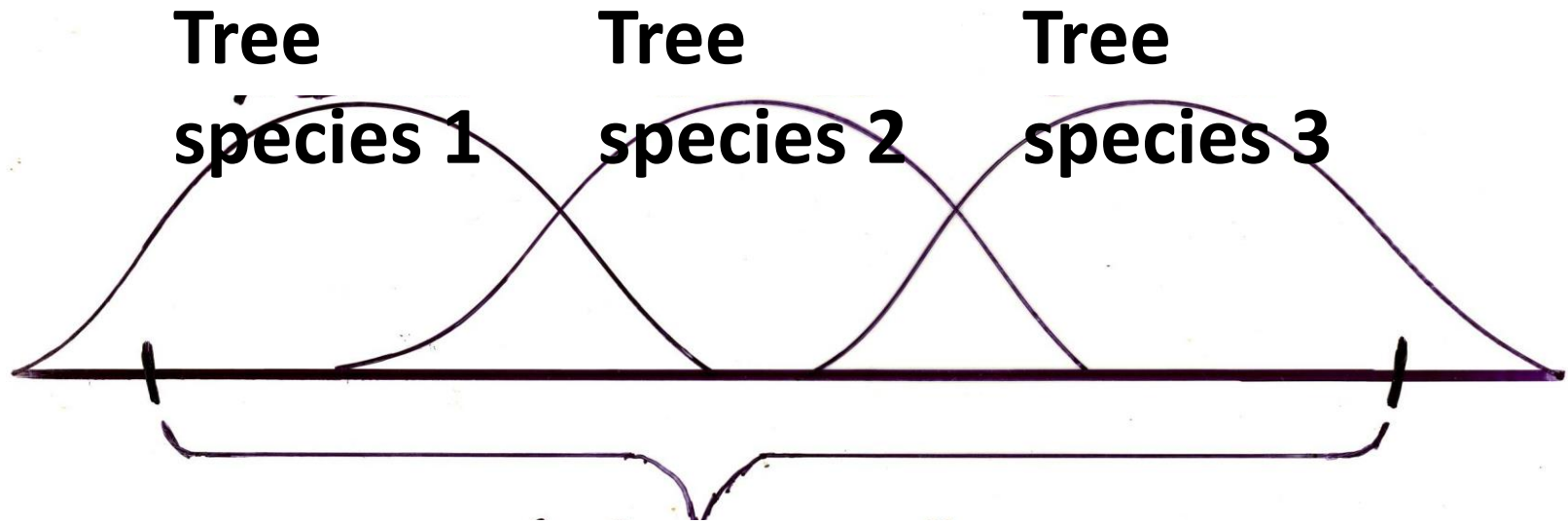

**Ecological conditions in  
the locality**



## Composition of mixed forest stands

- Goal of the regeneration - operational goal (the target composition of the species)
  - Clear function of the species in the mix (main, covering, improving, soil improving, reinforcing – or other functions in the case of purpose planting)
  - The stand should be considered in its future development (tending, cutting/harvesting)
  - The type of habitat must be followed (not according to the Management Set of Stands (MSS), but according to the Sets of Forest Types (SFT) and Assessed Soil-Ecological Units (ASEU))
  - Tree species of various rotation period, different growth intensity
  - Top quality wood, easy tending - mono-cultures
- 
- Individual mixtures
  - Row mixtures
  - Group mixtures (the smallest area for tending: 25 m<sup>2</sup>, minimum number is 6 trees)

- mixed in rows
- schematic mix

### General rules:

- wood yield - group and row mixing
- amelioration character - row, exceptionally individual
- cover species - rows, groups, individual trees
- modifying character - according to distribution of target species
- forest stand reinforcement - in rows

**MULTIPLE-PHASE REGENERATION !** ...by natural regeneration,  
improvement planting



# Row planting (spruce, beech)





# ***ARTIFICIAL FOREST REGENERATION***

## **SPACING AND DENSITY OF YOUNG PLANTATION**

# SPACING AND DENSITY OF YOUNG PLANTATION

- **spacing** = the geometric pattern after the planting (not defined by legislation); it is formed by connecting the closest plants with a line
- **density** = the number of the plants per 1 hectare (in the Czech Republic it is defined by legislation)

**Purpose planting:** the spacing and the density follow the planting intention and are defined by the function of the stand

## - “own” spacing

- regular (more or less regular crowns, closed stand earlier, schematic cutting/felling is possible),
  - advantage – we know where the trees are
  - disadvantage – we do not choose the best site
- irregular
  - advantage – we choose the best site (spot)
  - disadvantage – more damage made during treatment
- rows: compromise solution – constant distances of the rows; we choose the best place in the row

## - “technologic” spacing

- nest type (“packs”, cores of regeneration, bio-groups)
- zone type

*SPACING – REGULAR - “line” type planting is necessary*

**squared spacing**

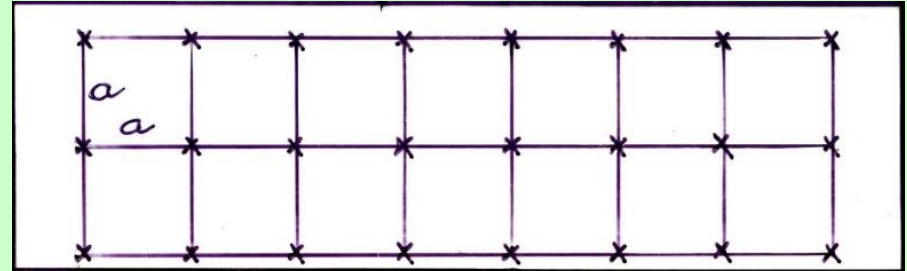

**rectangular spacing**

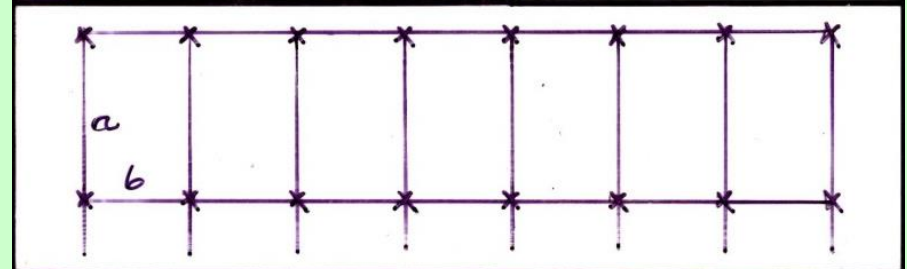

**triangular spacing**

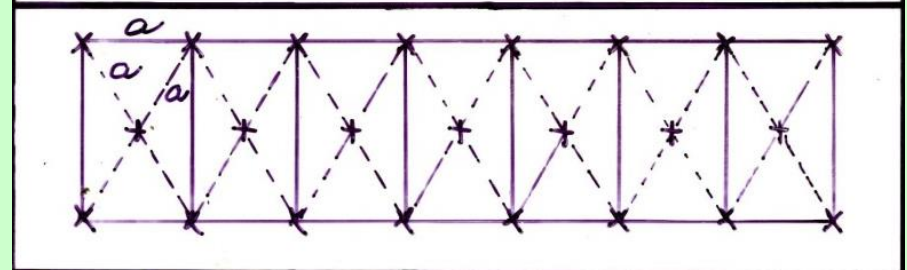

**five-pence spacing**

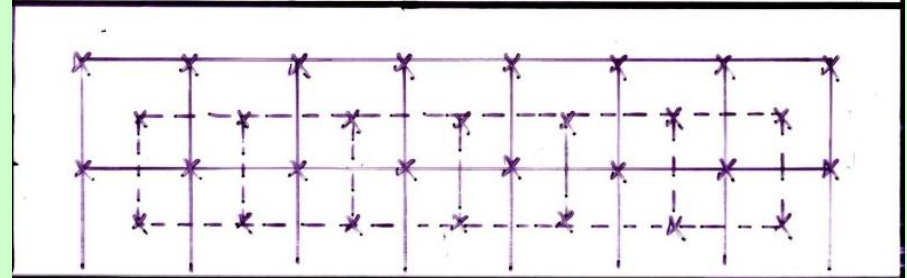





**Regular spacing – line type planting**





**Irregular spacing – trees marked with poles**



## Determination of appropriate density

- can be different if there is demand for weak assortments
- has influence on:
  - reforestation success (from the view of the functioning of the forest stand and the wood quality – no influence on the plant survival)
  - other tending fellings
  - economy
- in fact, it is necessary to find a biologically sustainable  
borderline
- the following must be respected
  1. the function of the forest stand
  2. the site
  3. the biologic aspects (growth characteristics)
  4. operation-related aspects (costs of the care and tending)



# THE COSTS OF REFORESTATION WITH WIDER SPACING (BAUMANN)

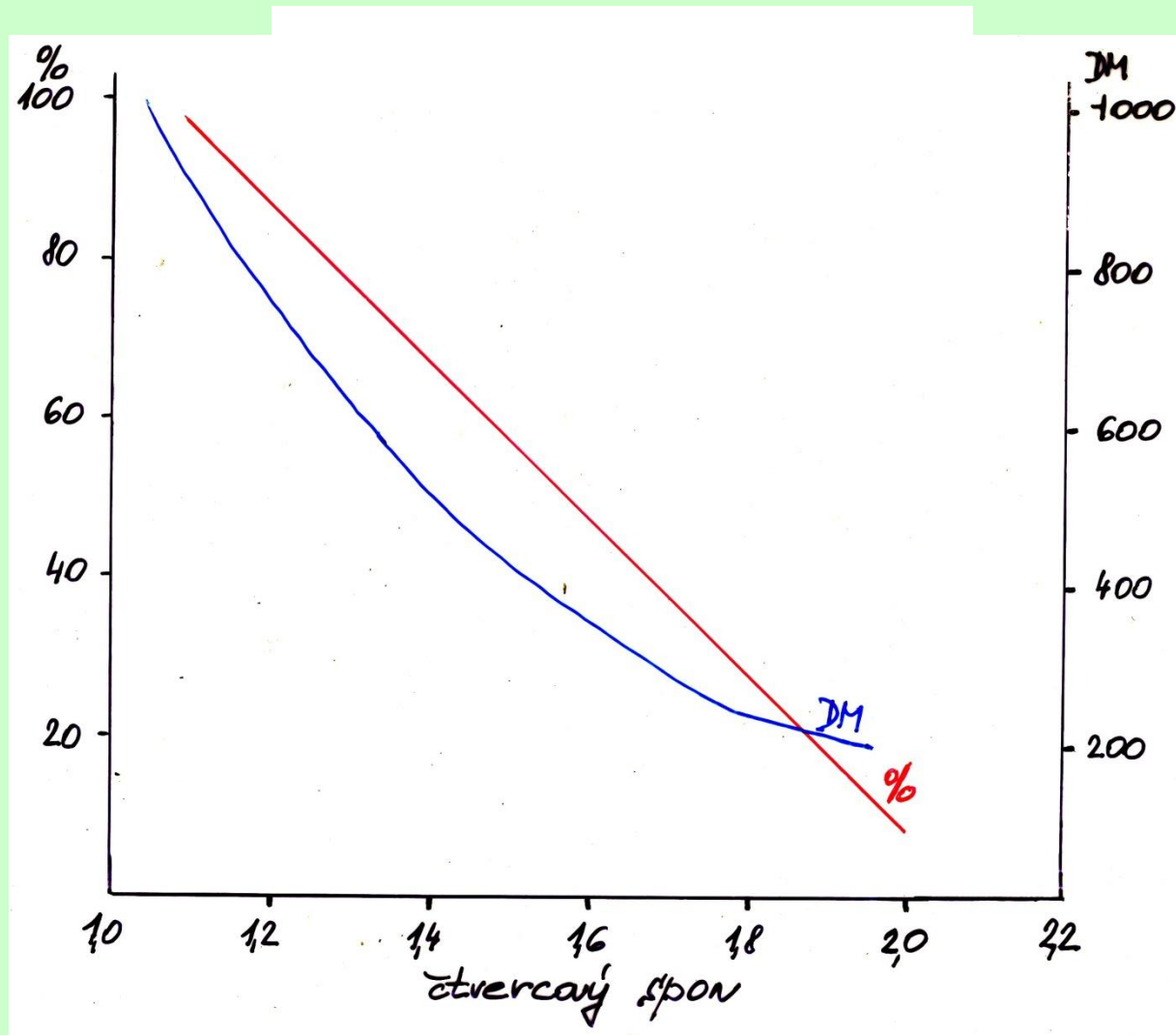

- **General starting points**

- quick closed stand = dense spacing (but this depends on the site)
- dry localities = less dense spacing
- high altitude = less dense spacing
- poor habitats = less dense spacing
- rich habitats = less dense and more dense spacing (“apple trees”)
- more developed stock = less dense spacing
- quick growing = less dense spacing
- protection against snow and air pollutants = less dense spacing

**More dense spacing = the base of the future quality of the forest stand, all-wood trunks, but higher threat from fungi**

# TIME WHEN SPRUCE FORMS A CLOSED STAND, VARIOUS DENSITY (Lokvenc 1984)

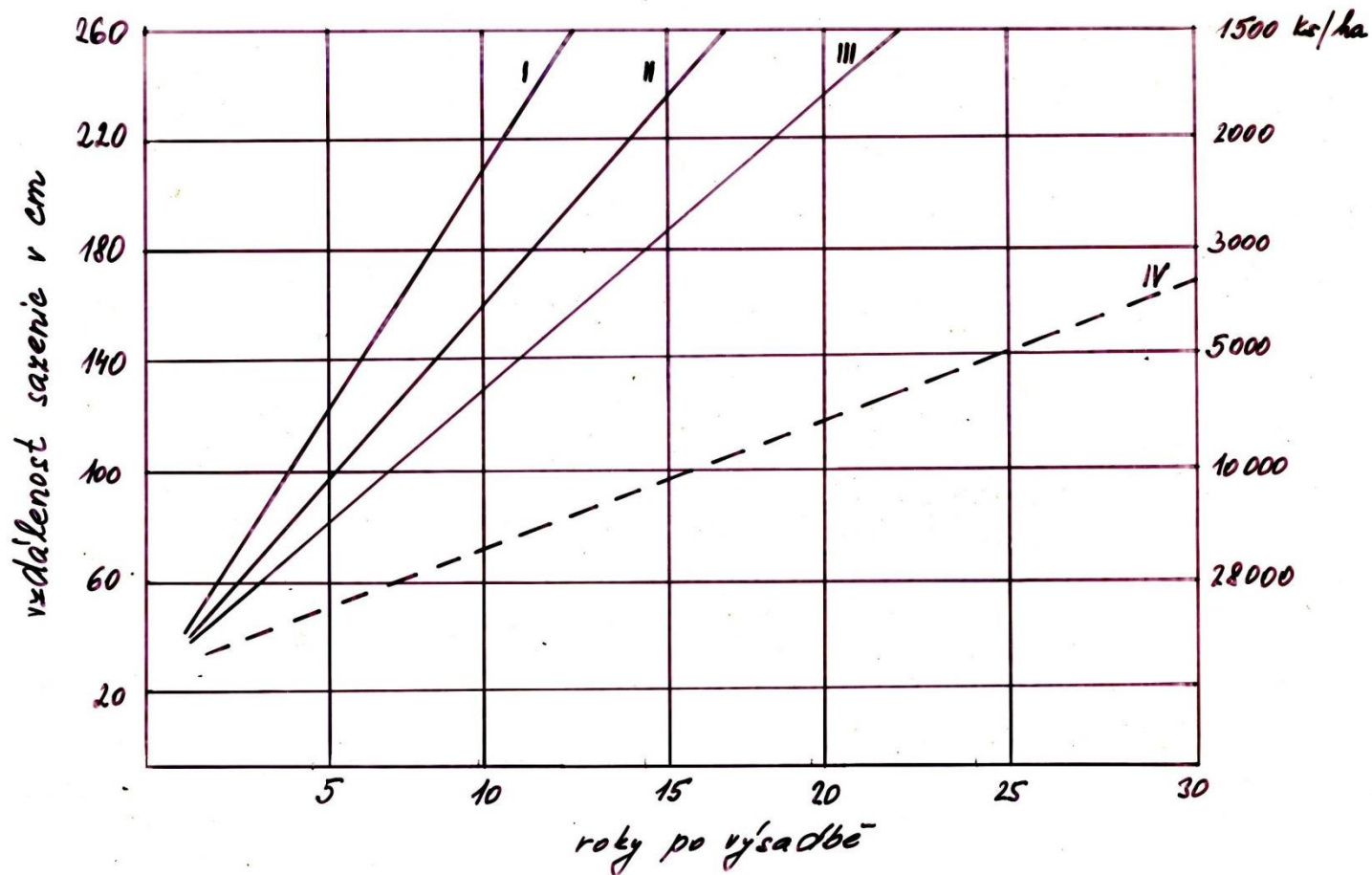

I - HS 45, 55, 75 (43, 53)  
 II - HS 51, 73, 57, 77, 39, 59

III - HS 71, 79  
 IV - HS 02, 03 (01)



- different characteristics of tree species must be taken into consideration
  - e.g. the beech, pine and oak need dense spacing - otherwise they would develop branches and form “apple-tree” like shapes
    - however, the ecotype is very important (German pines: 30 thous. pcs/hectare, Scandinavian pines: 7 thous. pcs/hectare)
    - for pine: there is the same effect if you make the plants per row more dense (higher crowns, irregular)
- more dense spacing does not protect against damage caused by game, pine weevil or weeds
- the influence of spacing on the overall production is not clear, but it is clear in terms of the assortments (more dense spacing = better assortments/quality of wood)
- the spacing is decreased when planting containerized planting stock, large-sized plants (by 20%)
- for forestry, there is a norm = min. hectare numbers of plants in planting
- at reclamation: 10,000 pieces per 1 hectare
- in preparatory stands: higher number than in the production forest

# DIRECTION OF ROWS IN PLANTING

- ***Normal habitat***
  - **Plane** – at sharp angle to the road (but this depends on the shape and location of the clearing)
  - **Slope** – following the fall line (bottom-up)
- ***Elimination of wind***
  - **Perpendicular** to the direction of the wind
- ***Suitable micro-climate***
  - **According to the type of tree species, movement of the Sun and wind**

**Thanks for your attention**